

# Soybean Production Handbook



Kansas State University  
Agricultural Experiment Station  
and Cooperative Extension Service

---



# Contents

---

Growth and Development of the Soybean Plant <i>Gary L. Kilgore, Extension Specialist, Crops &amp; Soils, Southeast</i> <i>Dale L. Fjell, Extension Specialist, Crop Production</i>	3
Selection of Soybean Varieties <i>William T. Schapaugh, Soybean Research Geneticist</i>	4
Seedbed Preparation and Planting Practices <i>Hans Kok, Extension Specialist, Soil and Water Conservation</i> <i>Dale L. Fjell, Extension Specialist, Crop Production</i> <i>Gary L. Kilgore, Extension Specialist, Crops &amp; Soils, Southeast</i>	8
Fertilization <i>David A. Whitney, Extension State Leader, Agronomy Program</i>	11
Weed Management <i>Dallas Peterson, Extension Specialist, Weed Science</i>	13
Irrigation <i>Danny H. Rogers, Extension Irrigation Engineer</i>	15
Soybean Insects <i>Randall A. Higgins, Interim Head, Department of Entomology</i>	19
Soybean Diseases <i>Douglas J. Jardine, Extension State Leader, Plant Pathology Program</i>	23
Harvesting Soybeans <i>Randal K. Taylor, Extension Specialist, Farm Power &amp; Machinery</i>	25
Drying and Storage <i>Joseph P. Harner III, Extension Agricultural Engineer</i>	27
Profit Prospects <i>Larry N. Langemeier, Extension Ag Economist, Farm Studies, &amp; Administrator, K-MAR-105</i>	29

Brand names appearing in this publication are used for product identification. No endorsement is intended, nor is criticism of similar products not mentioned. Persons using such products assume responsibility for their use in accordance with current label directions of the manufacturer.



# Growth and Development of the Soybean Plant

It is important to understand how soybeans grow and develop. Since their vegetative and reproductive growth stages occur for several weeks, many environmental conditions can affect final yield. Too much or too little moisture at specific stages of growth can affect performance. Even the type of soybeans, i.e. determinate or indeterminate, influences when a plant starts the flowering or pod-filling stage.

## Stages of Growth

A descriptive system has been worked out for soybean growth and development. Table 1 describes the stages.

Root growth begins at germination. Primary and lateral roots grow strong until R5. After R5, the shallower roots degenerate, but the deeper roots and laterals grow until R6.5. Nodulation occurs as early as VI and continues

through the V stages. Nitrogen is fixed by the rhizobium and is fed to the plant. Phosphorus and potassium are taken up by the roots — slowly at first, then rapidly. Rapid nutrient uptake occurs before a period of rapid growth. Most nutrients are taken up by the time the plant reaches R6 stage.

Stage R4 marks the beginning of the most crucial period of plant development in terms of yield determination. Stress (moisture, high temperature, nutrient deficiencies, lodging, or hail) occurring from R4 to R6.5 will reduce yields more than the same stress at any other period of development. Stages R4.5 through R5.5 are especially critical. Young pods are more prone to abort under stress than older pods and seeds. Stresses at this stage can greatly affect final performance.

**Table 1.** Description of soybean growth stages

Stage No.	State Title	Description
<b>Vegetative Stages:</b>		
VE	Emergence	Cotyledons above soil surface.
VC	Cotyledon	Unifoliate leaves unrolled so leaf edges are not touching.
VI	1st node	Fully developed leaves at unifoliate nodes.
V2	2nd node	Fully developed trifoliate leaf at node above unifoliate node.
V3	3rd node	Three nodes on main stem with fully developed leaves beginning with the unifoliate node.
V(N)	nth node	n = number of nodes on main stem with fully developed leaves beginning with the unifoliate node.
<b>Reproductive Stages:</b>		
R1	Beginning flowering	Open flower at any node on main stem. Indeterminate plants start at bottom and flower upward. Determinate plants start at one of the top 4 nodes and flower downward.
R2	Full bloom	Open flowers on one of the two uppermost nodes on main stem.
R3	Beginning pod	Pod 3/16 inch long at one of the four uppermost nodes on main stem.
R4	Full pod	Pod (3/4 inch) long at one of the four uppermost nodes on main stem.
R5	Beginning seed	Seed (1/8 inch) long in one of the four uppermost nodes on main stem.
R6	Full seed	Pod containing a green seed that fills pod cavity on one of the four uppermost nodes.
R7	Begin maturity	One normal pod on main stem has reached mature pod color.
R8	Full maturity	95% of pods have reached mature pod color. Approximate 5 to 10 days ahead of harvest.

# Selection of Soybean Varieties

## Varieties

The choice of variety is a key factor in profitable soybean production. Many varietal characteristics, such as maturity, lodging, and disease resistance, must be considered when selecting varieties to complement a production area. To help producers identify varieties best suited to their particular production situation, the Kansas Agricultural Experiment Station (KAES) conducts performance trials involving more than 200 soybean varieties each year at several locations in the state. A number of important traits are evaluated at each location, and additional characteristics are presented in the report. Results of these annual tests are available from the KAES or from county Extension offices.

When evaluating soybean varieties, producers should consider the following characteristics.

## Maturity

Maturity must be closely matched to the production environment and the cropping system. Maturity strongly influences how plant development complements or is affected by climatic conditions. Table 2 provides an overview of the developmental periods of varieties of differing maturities planted on different dates in Kansas.

**Table 2. Soybean Variety Growth Patterns**

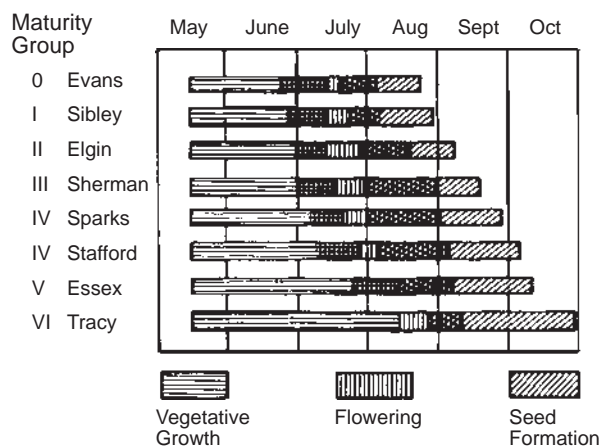

Soybean plants are sensitive to day length or photoperiod. The plants' response to day length controls the timing of the transition from vegetative to reproductive or floral development and the rate of physiological development. Varieties differ in their responses to day length. Some varieties flower under relatively short days while others flower under longer days. Varieties have been classified for photoperiod response based upon the ability of the variety to effectively utilize the length of the growing season in a region.

During the summer, day length increases from the southern to northern United States. This change in photoperiod results in regions of adaptation in the form of horizontal bands running east to west across the United States from the northern states to the Gulf Coast area. Each band extends 100 to 150 miles north to south.

Varieties adapted for full-season production to a particular region are assigned a maturity group number. Varieties in group 00 are adapted to the northernmost regions of North Dakota and Minnesota, and those in group VIII to the southernmost region of Florida and the Gulf Coast states. As the maturity group number increases, the lengths of the vegetative and reproductive stages of development are extended. A spread of about 10 days in maturity exists for varieties classified in the same maturity group.

Varieties are often moved north or south of their primary area of full-season adaptation to complement a production area. Because of the change in day length, when a variety is moved to the north, flowering will be delayed, and when it is moved to the south, flowering will be hastened.

Varieties adapted to Kansas generally are classified in maturity groups III, IV, and V (Figure 1). Varieties from group II (i.e. IA2022 and Kenwood 94) tend to mature too early even in a double-cropping system, except when grown in extreme northern or western Kansas. Group III varieties (i.e. KS3494 and Macon) perform well in northern Kansas and under irrigation throughout the state. Early group IV varieties (i.e. Stressland) can be grown throughout Kansas but perform best in the southern two-thirds of the state, while midgroup IV varieties (KS4694) are best adapted to the east central part of the state. Late IV and group V (i.e. KS4895, KS5292, and Hutcheson) varieties perform best in southeast Kansas.

Double-cropping is a common practice in Kansas. The soybean crop following wheat is usually planted 2 to 6 weeks later than the optimum date for highest yields. Since planting is delayed, often until the end of June or early July, a tendency exists to switch to a shorter season soybean variety to ensure the crop will mature before frost.

While planting too late a variety will increase the likelihood of frost damage, switching to a substantially earlier maturing variety should be resisted for two reasons. First, early maturing varieties planted late in the season will usually have limited vegetative development, short stature, and low yield potential. Second, the number of days to flowering, pod development, and maturity will be less in later plantings than earlier plantings of the same variety.

**Figure 1.** There are 10 maturity groups of soybean varieties. Those varieties adapted for use in southern Canada and the northernmost area of the United States are designated 00, and are the earliest maturing. The higher the number, the later the maturity and the further south the variety is adapted for full-season use. The lines across the map are hypothetical. There are no clear cut areas where a variety is or is not adapted.

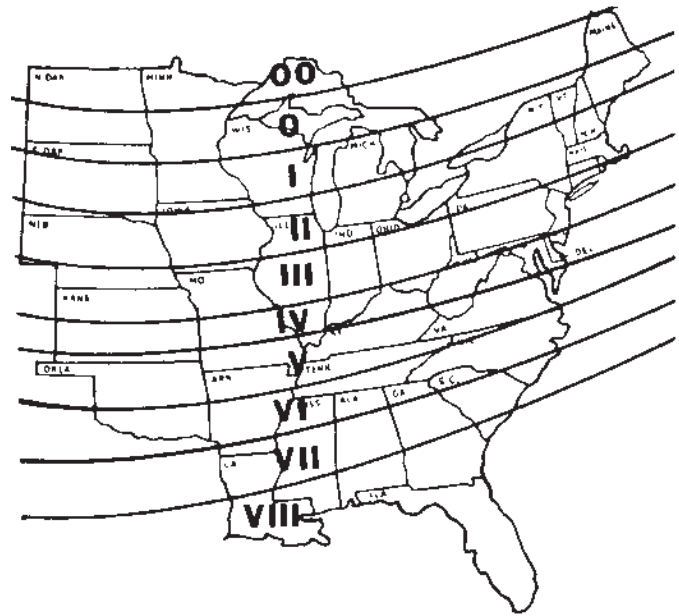

At the time of planting double-cropped soybeans, the day length has begun or will soon begin to shorten. This reduction in the day length, or the increase in the night period, causes plant development to speed up. Consequently, planting the same variety at the end of May versus the end of June does not delay maturity by one month. As a general rule, for every 3 days delay in planting, maturity is delayed by only 1 day. Since soybean development is hastened in later plantings, the highest yields in a double-cropped system are often achieved by the same variety or one slightly shorter in maturity than what is used in full-season production.

With environmental conditions fluctuating from year to year, planting varieties that vary in maturity should be considered by growers. Utilizing a range of maturities can reduce the risks associated with weather-related yield reductions and facilitates timely harvest and efficient machinery use.

## Standability

A variety must be able to remain erect throughout the growing season. Lodging during the vegetative or reproductive growth will disrupt the light penetration into the plant canopy and may reduce seed yield. Lodging late in the season may reduce harvest efficiency and increase harvest losses.

While varieties differ in their ability to resist lodging, environmental conditions greatly influence the tendency to lodge. Factors such as irrigation and high fertility tend to promote vegetative development and increase lodging. Increasing plant population causes the stems to become taller, more slender, and more prone to lodging.

If lodging has been a problem in the past, the grower should consider selecting a more lodging-resistant variety in addition to re-evaluating the seeding rate at planting. Lodging scores are provided for all entries in the Kansas Soybean Variety Performance Tests each year. However, in many of the tests, particularly the nonirrigated locations, lodging is not a consistent problem and conditions are often not present to differentiate among varieties. To better identify varieties with good standability, refer to environments where the most lodging is present.

## Stem Termination Type

Soybean varieties are classified on the basis of their morphological growth habit or stem termination type. The indeterminate growth habit is typical of most maturity group IV and earlier soybean varieties grown in Kansas. Maturity group V and later varieties typically possess the determinate growth habit.

Indeterminate varieties continue to grow vegetatively several weeks after flowering begins. Plant height can more than double after floral initiation. In contrast, determinate varieties complete most of their vegetative growth before flowering. Plant height can increase slightly in determinates after the onset of flowering, but generally 70 to 80 percent of the mature plant height is achieved prior to flowering.

At maturity the indeterminate plant tends to have a relatively even distribution of pods on the stem with a lower frequency toward the tip of the stem. The determinates tend to have a dense cluster of pods on the terminal raceme. Comparing varieties of similar maturity, indeterminates are usually taller than determinates.



While most of the varieties in groups 00 through IV possess an indeterminate growth habit and varieties in groups V to VIII possess the determinate growth habit, exceptions to this rule do occur. A few group IV and earlier varieties have been released that are determinates and a few indeterminates of group V or later maturity have been released.

The determinate growth habit in an early-maturity background results in short, compact plants that tend to have excellent lodging resistance. These early determinate (sometimes referred to as semi-dwarf varieties) varieties are recommended for production systems involving narrow rows, high seeding rates, early plantings, good fertility, and a yield potential in excess of 50 bushels per acre. While these early determinates can be productive, unless lodging is a problem, these varieties are not expected to be higher yielding than the best indeterminate varieties.

The determinate growth habit was originally incorporated into varieties to reduce plant height and lodging in environments with long growing seasons. The indeterminate growth habit, which has been incorporated into a few group V and later maturity backgrounds, tends to result in a tall, bushy variety with a long flowering period. These late indeterminates have been recommended for production in stress environments or double-cropped situations where vegetative production may be limiting. Research results from southeast Kansas have not shown any consistent advantage for the group V indeterminate variety compared to a similar maturity determinate variety.

## Disease Resistance

A wide range of environmental conditions prevail in the state during the growing season. These conditions influence the occurrence and severity of diseases attacking soybeans. Although numerous pathogens can affect soybean production, soybean cyst nematode (SCN), charcoal rot, and Phytophthora root rot are three of the more damaging soybean diseases in Kansas and nationwide. No single soybean variety can provide complete protection against all three of these diseases. However, a number of control measures involving variety selection can be used to keep losses due to these diseases to a minimum.

Soybean cyst nematodes are an increasingly serious problem. First identified in Kansas in 1985 in Doniphan County, the nematode has since been found in 16 Kansas counties. Yield losses due to the nematode have exceeded 30 percent on susceptible varieties planted in severely infested fields. As nematode population levels and distribution increase, producers must manage the nematode to maintain soybean yield, reduce nematode populations, and preserve durability of resistant soybean varieties.

SCN population density and race structure affect the ability of the nematode to cause damage. Race is determined by the number of cysts that are produced on four soybean differential genotypes: Peking, Pickett, PI88788, and PI90763 (Table 3). A female index on these differentials is expressed as a percent of the susceptible check: Lee. The female index is a measure of how well the nematode population reproduced on a specific soybean genotype. When reproduction is less than or equal to 10 percent, the response is considered positive (susceptible) for a given differential and negative (resistant) when the response is greater than 10 percent. These differentials, especially Peking and PI88788, have commonly been used as sources of resistance in variety development. Although not one of the differentials, PI437654 has been identified as resistant to all races of SCN and was used as the source of resistance in the variety Hartwig.

**Table 3.** Partial representation of the SCN race scheme

Race	Soybean Differential			
	Pickett	Peking	PI88788	PI90763
1	–	–	+	–
3	–	–	–	–
4	+	+	+	+
6	+	–	–	–
14	+	+	–	+

+, ≥ 10% of reproduction of the susceptible standard, Lee  
 –, < 10% of reproduction of the susceptible standard, Lee

SCN race 3 is the predominate race in Kansas, but several populations of race 1 have been identified. Races 4 and 6 have been recovered from one field each. Race 1 is of particular concern because this population occurs frequently and reproduces well on PI88788, which has served as the source of resistance for many new varieties.

Resistant varieties are recommended when soybeans are grown in SCN-infested conditions with population density levels greater than the economic threshold. Rotations that include nonhosts and susceptible varieties also are recommended to control population density. Proper use of resistant varieties requires that producers know the race of the nematode present. As mentioned earlier, different sources of resistance have been used to develop new varieties. Most resistant varieties will not prevent the buildup of all races of SCN, so knowing the race and monitoring the population density and race over time is important in preventing losses to the pathogen. Once the population density and race are known, a variety can be selected that will best prevent the buildup of the population.

To assist the producer in selecting productive, SCN-resistant varieties, a Soybean Variety Performance Test location is specifically devoted to evaluating variety



performance in an infested field. Results from this southeast Kansas location are published each year in the test booklet. Included in the report is a listing identifying the source of resistance for each SCN-resistant variety.

Charcoal rot is an important soybean disease that is associated with drought stress and high temperatures. The most recent estimates quantify the U.S. production loss attributed to charcoal rot at more than 30 million bushels per year. Only losses from soybean cyst nematode and *Phytophthora* root rot exceed the estimates for charcoal rot nationwide.

Charcoal rot is the only major soybean disease without good genetic resistance. Advances in recent research on charcoal rot disease have demonstrated that varieties differ in their reaction to infections by the pathogen, but higher levels of resistance are needed to effectively combat the disease. While no completely resistant varieties have yet been identified, the differences noted among varieties provide hope that high levels of resistance can be identified in plant introductions or other varieties.

Currently, the best recommendation for minimizing losses to charcoal rot is to select planting dates and variety maturity combinations that minimize drought and heat stress experienced by the plants and produce the highest yield. Final yields are a good indication of the levels of drought and heat experienced by the crop during critical periods of development. This strategy is generally accomplished in eastern Kansas by delaying planting and selecting a later maturing variety. In central Kansas, earlier plantings of group III varieties may provide the best option for drought avoidance.

*Phytophthora* root rot does not represent a widespread problem in Kansas, but isolated areas of infestation do occur occasionally. Varieties are available that provide a high level of resistance to *Phytophthora*. Like SCN, *Phytophthora* is an organism that is present in fields in a number of different forms or races. More than 25 races of *Phytophthora* have been described. When losses to the pest are known to be serious, a variety with specific resistance to multiple races of the pathogen should be selected. Each resistance gene will control some, but not all, races. Varieties that carry the single gene  $Rps_1^k$ ,  $Rps_1^c$ , or  $Rps_3$  should provide control for most of the virulent races found in Kansas. Gene  $Rps_1^a$  also offers multirace resistance, but to fewer races identified in Kansas than the preceding genes. Under less severe infestations, selecting a variety with a high level of field tolerance may be a viable alternative for control of *Phytophthora* root rot. Tolerance is expressed in some varieties by being able to grow and produce an acceptable yield once they have survived the seedling stage, even though they are infected with *Phytophthora*. Tolerance ratings and resistant genes present are listed for many varieties in the *Kansas Performance Tests with Soybean Varieties*.

Varieties with resistance to other destructive diseases, such as stem canker and soybean sudden death syndrome are available. Fortunately, these diseases generally are not considered important in Kansas. Little value exists in growing varieties resistant to these and many other diseases unless the disease has been diagnosed in the field in previous years.

Additional information on management strategies to control diseases can be found in the section on soybean diseases.

## Blends

Along with a large choice of varieties, producers also may select from a number of blends (mixtures of two or more varieties) being marketed in the state. The process used to select an appropriate blend is similar to that used in varietal selection. However, unlike varieties that maintain their genetic identity season after season with proper handling, the frequency of the individual components of a blend may change after only one season in production. If this occurs, the basic characteristics of the blend also may change, affecting performance. To ensure a blend contains the correct proportion of components each season, the components must be mixed and the seed purchased each year.

## Shattering

Environmental conditions prevalent during the harvest season in Kansas often test a variety's ability to resist shattering. As a regular component of the Kansas Soybean Variety Performance Tests, entries are evaluated for shattering resistance. These evaluations should indicate the relative shattering response of a variety when left in the field about 2 weeks after maturity or about 1 week later than the optimum harvest time. To minimize shattering in blends, select a brand in which the earliest and latest maturing components do not differ by more than a few days.

## Iron Chlorosis

In the central and western portions of the state, iron chlorosis is a common problem on highly calcareous soils. Although no soybean varieties are available with complete resistance to iron chlorosis, moderate levels of tolerance do exist that allow for improved soybean production in all but the most severe problem areas. Often the developer of a variety will know how a particular variety responds to conditions favoring the development of iron deficiency chlorosis. Every few years researchers with the KAES conduct variety evaluations for chlorosis tolerance. Details of these evaluations may be found in KAES bulletins and the variety performance tests results.

## Yield Potential

Harvestable yield is obviously an important characteristic to consider when selecting a soybean variety. Although improvements in yield do not occur at a rapid pace, development of new, disease-resistant varieties and integration of those varieties into cropping systems account for approximately half of the improvements in soybean yields in Kansas. This genetic contribution represents an increase in yield of 0.1 to 0.2 bushels per acre per year. Each year many newly released varieties will out-yield previous releases, particularly older varieties, by 10 to 20 percent in various production situations.

To make the best possible decision regarding yield potential, consult results from public trials, county test plots, farmer evaluations, and private tests for information on variety performance. Since the performance of any variety will vary from year to year

and from location to location depending on factors such as weather, management practices, and variety adaptation, carefully consider the performance of a variety across several locations for 2 or more years. An average across environments will provide a better estimate of genetic potential and stability than a single or only a few test sites.

## Selection Summarized

Selecting a variety or a number of varieties for production is one of the many decisions the soybean producer must make throughout the year. The substantial differences in yield potential among varieties under various conditions make this decision one of the most important. Final selection should be based on a thorough understanding of the production conditions and a careful assessment of varietal characteristics that best complement those conditions.

# Seedbed Preparation and Planting Practices

Soybeans need a soil that is warm, moist, well-supplied with air, and provides good contact between the seed and soil for rapid germination. An ideal seedbed should accomplish the following:

- control weeds,
- conserve moisture,
- preserve or improve tilth,
- control wind and water erosion, and
- be suitable for available planting and cultivating tools.

## Seed Quality

Soybean seeds are extremely fragile and subject to damage by handling, augering, and transporting. Seed moisture influences the extent of damage; drier seed is more easily damaged than seed with higher moisture content. Splits and cracks in seed can be seen easily, but considerable internal injury can go undetected. The only way to determine seed viability is to have a germination test run. The germination rate should be 85 percent or greater.

**Figure 2.** Soybean planting dates

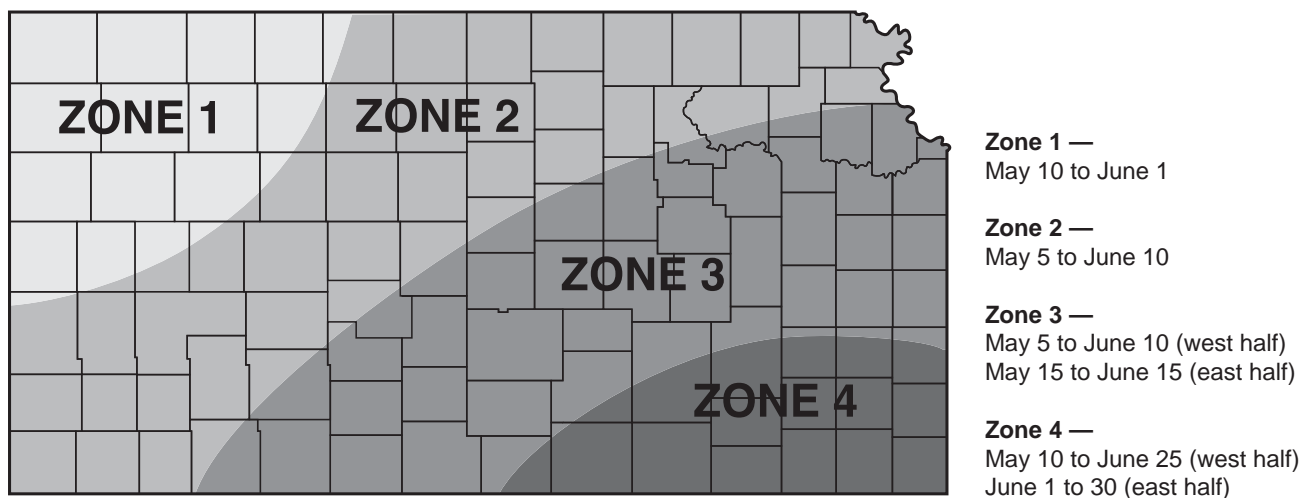

## Planting Date

Nonirrigated soybeans produce well over a wide range of planting dates, if moisture is available (Figure 2). However, rainfall distribution and amount during pod-filling determines final yield. Using two planting dates may be good insurance against inadequate moisture.

Nonirrigated soybeans may be planted from May 1 until June 20 in most Kansas areas, but mid-May is suggested for northeast and east central Kansas, late May to early June for central areas, and early to mid-June for southeastern Kansas. Nonirrigated soybeans are seldom grown in western Kansas, but if they are, they should be planted in early to mid-May.

## Row Width

Most Kansas producers use a 30-inch row width since it is well suited for other row crops, allows cultivation for weed control, and out-yields wider row spacings. Under irrigation, the irrigation method dictates the row width.

Row widths narrower than 30 inches, although not a new concept, have several advantages. They provide early canopy cover, improved light interception, better plant or stand survival, ease of harvest, and increased seed yields. There appears to be only a slight yield advantage for narrow row spacing over wide row spacings in Kansas. The narrow row soybean yield advantage has been quite variable. Stress reduces or eliminates any gains from narrow row spacing, but under irrigation, the increased yield advantage is greater and more consistent.

Problems with poor seedling emergence or stand establishment often are associated with narrow row spacings since there are fewer seeds per foot of row to push through a crusted soil. Uneven seed metering by the drill or poor seed-soil contact also can cause stand problems. Press wheels are needed to improve the seed-soil contact and aid germination and seedling emergence.

Early-maturing varieties tend to respond better to narrow row widths than later-maturing varieties, although they may not be as productive. Varieties that perform well in wide rows usually perform well in narrow row spacings.

Current research shows narrow-row (7 to 8 inches) beans are equal to wider rows (30 inches) when weeds are controlled and plant population per acre is not increased.

A 10-percent yield increase is noted for narrow rows over 30-inch rows when planted after June 5. It is very important to keep plant population the same on a per-acre basis. Note that 105,000 plants per acre in 30-inch rows is equal to six plants per foot of row. In 8-inch drill rows, that same population per acre equals 1.6 plants per foot of row. Do not overplant when drilling soybeans. Because of poor seed-soil contact with some drills, seeding rates may need to be increased by 15 percent over that with the row planter. In high-yielding conditions (greater than 40 bushels per acre), seeding rates may again need to be increased.

## Plant Population

Since soybean seed size varies among varieties and within the same variety grown in different environments, it is essential to consider planting rates in terms of *seeds per foot of row* or *seeds per square foot*. It is not uncommon to see sizes ranging from 12.6 grams per 100 seeds to 18.9 grams per 100 seeds (2,400 to 3,600 seeds per pound).

If one variety has 2,400 seeds per pound and another 3,600 seeds per pound, and a producer planted both at a rate of 60 pounds per acre, the large-seeded variety would have a seeded population of 144,000 seeds per acre ( $2,400 \times 60 = 144,000$ ) while the small-seeded variety would have 216,000 seeds planted per acre ( $3,600 \times 60 = 216,000$ ). If 60 pounds of both varieties were planted at nine seeds per foot of row in 30-inch rows, the large-seeded variety would plant 0.92 acres while the small-seeded variety would plant 1.37 acres.

### Calculating seeded or plant population

Equation 1: Seeded or plant population

43,560 sq. ft. per acre  $\times$  (12 inches  $\div$  row spacing in inches)  $\times$  seeds or plants per row-foot

$$43,560 \times (12 \text{ inches} \div 30 \text{ inches}) \times 9 \text{ seeds per row-foot} = 156,816 \text{ seeds per acre}$$

Equation 2: Number of seeds or plants needed per row-foot to obtain desired population

(desired seeded or plant population  $\div$  43,560 sq. ft. per acre)  $\times$  (row spacing in inches  $\div$  12 inches)

$$(140,000 \text{ seeds per acre} \div 43,560) \times (30 \text{ inches} \div 12 \text{ inches}) = 8 \text{ seeds per row-foot}$$

**Note:** No adjustments for germination or emergence have been made in these examples.

To minimize seed costs, producers need to know precisely the number of seeds planted per foot of row. There are two simple equations to calculate the final seeded or plant population and the number of seeds or plants per row-foot to obtain a desired plant population. These equations, shown later, are helpful in determining the amount of seed to purchase and in calibrating planting equipment. The optimum planting rate may be adjusted for different growing conditions such as upland versus bottomland, irrigated locations, and planting dates.

Interplant competition increases with increased plant populations resulting in taller plants with smaller stem diameters, which accentuates lodging problems and fewer branches, pods, and seeds per plant. Low plant populations or thin stands cause low branching and pods produced lower on the stem, which increases harvest losses.

The recommended planting rate for various row spacings is presented in Table 4. It should be noted as row spacing decreases, the number of seeds or plants per foot of row also decreases to obtain the same populations. Since early-maturing varieties generally do not produce a dense canopy, the planting rate should be adjusted upward. Other situations such as upland versus bottomland sites or late plantings may require the planting rate be adjusted either up or down. Drier soil conditions usually require a lower planting rate while late plantings require increased rates to compensate for the lack of canopy growth.

**Table 4.** Suggested planting rate and plant population for various row widths

Row width	Seeds per linear ft. <sup>A</sup>	Plants per linear ft. <sup>B</sup>
30 inches	7.5	6
20 inches	5	4
10 inches	2.5	2
7.5 inches	1.875	1.5

<sup>A</sup> Three seeds per square foot regardless of row width

<sup>B</sup> Assumed 80 percent field emergence

## Planting Depth

The optimum planting depth for soybean seeds is 1 to 1.5 inches, no more than 2 inches in sandy soils. With early plantings, slightly shallower seed placement will speed emergence, and with late plantings in dry soil, slightly deeper placement may be necessary to put the seed in contact with moisture. The use of press wheels will help firm the soil resulting in good seed-soil contact for rapid germination and uniform emergence. Certain herbicides necessitate deeper placement to reduce seedling injury. Check herbicide labels for specific planting recommendations.

Soybeans can emerge from plantings deeper than 2 inches, but seedling emergence is slowed. The seedlings are subjected to more disease organisms, and poor stands frequently occur on heavy soil from surface crusting. When soil crusting occurs, the hypocotyl of the seedling is not able to break through the crust. If the crust is left undisturbed, the hypocotyl arch or crook will break or the seedling will grow laterally, never emerging. A rotary hoe is useful for breaking a crusted soil and allowing the seedlings to emerge, but it will reduce the plant population slightly.

## Double Cropping

Double cropping is the practice of planting a second crop after the first crop is harvested. If double cropping is to be successful, soybeans must be planted immediately after small-grain harvest.

Double cropping is most successful in east central, southeast, and south central Kansas (where irrigated). Available growing season and adequate moisture are often limiting factors. Substantial yield reductions occur when planting is delayed from mid-June to mid-July. Since growing time and moisture are limiting, many producers burn the small-grain stubble and plant using a no-till planter or till lightly with a disk or field cultivator and then plant.

More producers are using no-till planters and planting directly into the small-grain stubble, which saves both time and moisture. Major tillage operations using a moldboard plow or offset disk delay planting and cause a loss of valuable soil moisture. Some soils may require tillage to eliminate hard pans or compaction problems prior to planting.

Double-cropped soybeans may experience poor early growth due to excessive small-grain straw. This poor growth and leaf chlorosis can be corrected or avoided with a light application of nitrogen.

## Conservation Tillage

A number of tillage and planting systems can be used in producing soybeans. These systems may include primary or secondary tillage, both, or no preplant tillage.

Tillage and planting systems that provide for profitable crop production with minimal soil erosion are often referred to as conservation tillage systems, an umbrella term that includes reduced-till, mulch-till, ecofallow, strip-till, ridge-till, zero-till, and no-till methods. The emphasis in conservation tillage is erosion protection; however, savings in water, fuel, labor, and equipment may be additional benefits. Conservation tillage is an integral part of many conservation plans for highly erodible land (HEL) as a result of the conservation compliance provisions of the 1985, 1990, and 1995 farm bills.



The chance for erosion is greater on soils planted to soybeans than most other crops. Soybeans leave the soil surface loose and mellow, which can contribute to greater erosion losses. Soybeans produce less residue than most other crops, and the residue is fragile and easily broken down. Soybeans typically produce 45 pounds of residue per bushel of grain, compared to 60 pounds of residue for corn and grain sorghum and 100 pounds of residue per bushel of wheat. Very little soybean residue is standing after harvest. Standing residue is more effective than flat residue in reducing wind erosion losses. For these reasons, conservation tillage or other erosion-control practices are very important before, during, and after soybean production.

Conservation tillage systems protect the soil surface from the erosive effects of wind, rain, and flowing water either by covering the soil surface with crop residue or growing plants or by increasing the surface roughness or soil permeability. Water erosion losses for different tillage systems following a 2-inch rainfall are shown in Table 5.

A common goal of conservation tillage systems is to reduce soil erosion losses below the soil loss tolerance or “T” value. Soil loss tolerance is an estimate of the maximum annual rate of soil erosion that can occur without affecting crop productivity over a sustained period. Soil loss tolerances for Kansas cropland are normally in the range of 4 to 5 tons per acre per year. Soil loss tolerances for specific soil series can be found in soil surveys or from Natural Resources Conservation Service, formerly Soil Conservation Service, personnel.

The amount of residue necessary for protection against wind and water erosion depends on several factors such as climatic conditions and patterns, soil erodibility, surface roughness, field length, length and steepness of slope, cropping practices, and other conservation practices. A rule of thumb suggests leaving a 30-percent residue cover on the soil surface after planting where water erosion is the primary concern. Where wind erosion is a problem, 30 percent residue or its equivalent

is required on the soil surface during the critical wind erosion period. The actual level of residue required to minimize soil loss on a specific field may vary. Local NRCS personnel can provide assistance in determining residue needs. In situations where conservation tillage alone may not adequately protect the soil from erosion losses, it can be integrated with other conservation practices such as terracing, contouring, strip cropping, or windbreaks to provide the necessary erosion protection.

**Table 5.** Soil losses for various tillage systems in soybean, corn, and wheat residue

Tillage System	Corn Residue		Soybean Residue	
	Cover (%)	Soil loss tons/acre	Cover (%)	Soil loss tons/acre
Plow, disk, disk, plant	4	10.1	2	14.3
Chisel, disk, plant	13	8.3	7	9.6
Disk, disk, plant	--	--	5	14.3
Disk, plant	15	6.6	9	10.6
No-till plant	39	3.2	27	5.0

Wymore silty clay loam, 5 percent slope. Two inches applied water at 2.5 inches/hour.  
(Data from E.C. Dickey, University of Nebraska-Lincoln)

Several Kansas State University experiment fields and stations in eastern and north central Kansas have studied the effects of various conservation tillage practices on soybean yields. In most cases, the form of tillage used did not influence yields significantly. However, in some years no-till soybean yields were lower than yields from reduced or conventional tillage. The reduction in no-till soybean yields occurred when soybeans were grown continuously or on poorly drained soils. Ridgetill is usually a good alternative on poorly drained soils. Switching to a crop rotation system and avoiding no-till on poorly drained soils as well as obtaining adequate plant stands, weed control, and uniform residue distribution from the previous crop are all important in conservation tillage soybean production.

## Fertilization

Fertile soils that produce high yields of other crops also will produce high yields of soybean. Total nutrient uptake by soybean depends on yield obtained, which will vary with season, variety, soil, and cultural practices. Soybeans take up relatively small amounts of nutrients early in the season, but as they grow and develop, the daily rate of nutrient uptake increases. Soybeans need an adequate supply of nutrients at each developmental stage for optimum growth.

High-yielding soybeans remove substantial nutrients from the soil, and this should be taken into account in an overall nutrient management plan (Table 6). Soybeans contain a higher amount of potassium in the grain than does wheat, corn, or grain sorghum and thus remove more potassium.

**Table 6.** Nutrient amounts in a 40-bushel-per-acre soybean crop

Nutrient	----- Quality in -----	
	Grain	Stover
Nitrogen (N)	150	— lbs — 52
Phosphorous (P <sub>2</sub> O <sub>5</sub> )	35	12
Potassium (K <sub>2</sub> O)	55	39
Sulfur (S)	7	7
Calcium (Ca)	7	
Magnesium (Mg)	4	
Copper (Cu)	.04	
Manganese (Mn)	.05	
Zinc (Zn)	.04	

Source: Adapted from National Plant Food Institute

## Lime

The nodule bacteria (*Bradyrhizobium japonicum*) associated with soybean roots function best in soils of near-neutral pH. A near-neutral pH also favors availability of most plant nutrients.

The need for lime can be accurately determined by a soil test. Lime recommendations are typically made for pounds of effective calcium carbonate (ECC) to bring the top 6 or 7 inches of soil to pH 6.8. For maximum effectiveness, the lime must be thoroughly incorporated into the soil. Lime is relatively insoluble and may take several months to complete the neutralization reaction.

Lime application rates should be adjusted for tillage methods (incorporation depth). If shallow incorporation is done, then the recommended lime rate for the top 6 or 7 inches of soil should be adjusted.

## Nitrogen

Under normal conditions, soybeans will need no nitrogen fertilizer as the nodule bacteria will fix sufficient nitrogen for optimum growth. If soybeans have been grown recently on the land and were well nodulated, reinoculation probably is not necessary. However, if there is any question about the abundance of nodule-forming bacteria in the soil, or if the land has no previous history of soybean production, inoculation of the soybeans is recommended. Handling, storage, and use should be in accord with the package label to assure viable bacteria in the inoculant.

Until nodulation occurs, the soybean plant depends on soil nitrogen for growth. Soybeans planted where a large amount of wheat straw has been freshly incorporated into the soil may respond to a starter application of 10 to 20 pounds of nitrogen. The wheat straw causes a temporary tie-up of the soil nitrogen by microorganisms decomposing the straw. On newly leveled land being planted to soybeans for the first time, an application of 30 to 40 pounds of nitrogen per acre may be necessary

because of the extremely low available nitrogen in the soil. Recent research has shown that under high yield conditions (greater than 60 bushels per acre) an application of 20 to 40 pounds of nitrogen at the R-3 stage has resulted in a fairly consistent 5- to 10-percent yield increase.

## Phosphorus

Phosphorus applications should be based on a soil test. Consistent responses to direct phosphorus fertilization generally have been restricted to soils testing very low or low in available phosphorus. With medium testing soils, responses have been erratic and normally quite small. Phosphorus recommendations based on soil tests are given in Table 7.

Limited work with placement has revealed little difference between planting-time banded starter and broadcast application methods. Phosphorus moves little in the soil, making it necessary to incorporate broadcast applications. If a starter fertilizer is used, the material should be placed to the side and below the seed. Soybean seeds are very easily injured by fertilizer, therefore, no direct seed contact with fertilizer is advised. No difference exists between phosphorus fertilizer sources.

**Table 7.** Phosphorous recommendations for soybeans (based on soil tests)

Soil Test Level (ppm)				
Very Low	Low	Medium	High	Very High
0-5	6-12	13-25	26-50	> 50
30-40 *	20-30	0-20	none	none

\* pounds per acre of P<sub>2</sub>O<sub>5</sub>

## Potassium

Soybean seeds are relatively high in potassium in comparison to corn, wheat, and grain sorghum. This means removal of potassium by soybeans is greater than for those crops on a per-bushel basis when the grain only is removed.

As with phosphorus, a soil test is the best index of potassium needs. Soils testing very low or low should be fertilized with potassium, either as a banded starter at planting or broadcast and incorporated. Potassium should not be placed in contact with the soybean seed because of possible salt injury.

Yield increases from potassium are comparable to those with phosphorus under very low and low soil test levels. Potassium recommendations based on soil tests are given in Table 8.



**Table 8.** Potassium recommendations for soybeans (based on soil tests)

Soil Test Level (ppm)				
Very Low 0-40	Low 41-80	Medium 81-120	High 121-160	Very High > 160
60-80 *	40-60	20-40	0-20	none

\* pounds per acre of K<sub>2</sub>O

## Zinc

Soybeans have been found to respond to zinc application to soils testing low in available zinc. Zinc deficiency is most likely to occur under high-yield conditions, in cut areas of fields leveled for irrigation, or in eroded areas that are low in organic matter. The need for zinc should be determined by soil tests.

Zinc fertilizer can be either banded at planting or broadcast preplant with little difference in response when applied at an adequate rate (Table 9). Both organic and inorganic zinc sources (chelates and nonchelates) can be used. The chelates are considered three to five times more effective than the inorganic sources. Manure applications also are effective in eliminating zinc-deficiency problems.

**Table 9.** Zinc recommendations for soybeans (based on soil tests)

	DTPA Soil Test Level (ppm)		
	Low 0-0.5	Medium 0.51-1	High > 1
Irrigated	8-10 *	2-5	none
Nonirrigated	2-5	none	none

\* pounds per acre of Zn based on the use of zinc sulfate as the zinc source

## Iron

Iron deficiency may be encountered on calcareous soil in western Kansas. Soil applications of iron materials presently available are not economically effective. For this reason, foliar sprays or manure applications are recommended to correct an iron deficiency. Again, soil tests can be used to predict the need for iron.

## Other Nutrients

In general, soybeans are unlikely to respond to other nutrients. Calcium and magnesium are relatively abundant in most Kansas soils. Liming of acid soil supplies sufficient calcium so a deficiency of this element would not be expected.

Molybdenum deficiencies are more likely in strongly acidic soils than in neutral or only slightly acidic soils. Liming acidic soils tends to make native molybdenum more available to plants. Thus, an adequate liming program should ensure against molybdenum shortages in most soils.

Research with sulphur, boron, copper, and manganese has not shown consistent responses. These elements should not be a problem for optimum soybean yields in most soils where soybeans are now being produced.

If a deficiency of one or more of these nutrients is suspected, application should be made to a small test area to see if a response can be obtained. Producers should remember that several of these micronutrients are toxic in relatively small amounts beyond optimum levels. It is much harder to remove the excess than to add the nutrient.

# Weed Management

Weeds growing with soybeans compete with the crop for light, moisture, and nutrients. Uncontrolled weeds reduce soybean yields and interfere with harvest. According to a 1992 report published by the Weed Science Society of America, weeds were estimated to cause more than \$13 million in losses to Kansas soybean production each year.

An effective weed-management program requires knowledge of the potential weed problems and implementing a timely weed-control program. Soybeans are very competitive with weeds once the soybeans develop a canopy, but early emerging weeds can cause serious problems. Thus, early-season weed control is the key to providing the soybeans with a competitive advantage and minimizing the effect of weeds. The

most effective weed-control programs involve a variety of control practices in an integrated weed-management system, including crop rotation, cultivation, sound agronomic practices, and judicious use of herbicides.

## Common Weed Problems

Summer annual grass and broadleaf weeds like crabgrass, foxtail, pigweed, velvetleaf, and cocklebur are common weed problems in soybeans. These weeds germinate in the spring and summer and produce seed before they die in the fall. Germination of summer annual weeds depends on soil moisture and temperatures. A well-timed cultivation or herbicide treatment can greatly reduce densities of summer annual weeds.

Winter annual weeds like henbit, mustards, downy brome, horseweed (marehail), and mustards generally are not a problem in soybeans, except in no-till production. Winter annual weeds germinate in the fall and produce seed the next spring or summer. They can be controlled with tillage or burndown herbicide treatments prior to planting soybeans.

Perennial weeds that regrow each year from an established rhizome or root system are very competitive and difficult to control. Perennial broadleaf weeds such as field bindweed, common milkweed, and hemp dogbane are more difficult to manage in soybeans than perennial grass weeds like johnsongrass. Selective herbicides are available to help control johnsongrass, but are not readily available for control of perennial broadleaf weeds. Perennial broadleaf weeds are best managed by crop rotation or treatment between crops.

## Preventive Weed Control

Preventive weed control measures are economical and prudent. Introduction of new weed species into fields can dramatically increase weed control costs. Weeds can be inadvertently introduced into clean fields with contaminated crop seed, tillage and harvest equipment, manure applications, animal movement, and flood waters. Some of these factors are controllable, while others are not.

Planting weed-contaminated crop seed is one of the most common ways to spread serious weed problems to new fields. This is especially true for certain weeds that are difficult to separate from soybeans, like cocklebur, morningglory, and black nightshade. Soybean seed should be cleaned and inspected for weed seed before it is planted.

Clean equipment and combines when moving between infested fields. Root or rhizome segments of perennial weeds like johnsongrass or field bindweed can easily be transported within fields or between fields on field cultivators and other tillage implements. Combines are excellent at collecting and dispersing weed seed to other fields. If possible, harvest the clean fields or parts of fields before harvesting weedy areas, and clean the combine between fields.

Hand removal of scattered, newly introduced weeds may be a wise investment if done in time to prevent a serious weed problem from becoming established in a field.

## Cultural Practices

Cultural practices can have a tremendous influence on the type and severity of weed problems. Crop rotation, tillage system, livestock wintering, and other field-management practices affect weed populations and competition in soybeans.

Production practices that encourage quick soybean emergence and canopy development can give the crop a competitive advantage over many weeds. Proper seed placement, fertility management, planting date, and seeding rates can help establish a healthy, competitive soybean crop.

Planting configuration and seeding rate influence soybean canopy development. Solid-seeded soybeans tend to form a canopy more quickly and are more competitive with late emerging weeds than soybeans planted in wider rows. However, drilled soybeans cannot be cultivated, so earlyseason weed control becomes more critical. Soybeans planted in wider rows can be cultivated, which may reduce the need for herbicides.

Crop rotation is one of the most effective ways to manage certain weed problems specific to a crop. A serious infestation of velvetleaf, cocklebur, or devilsclaw in soybeans may be best managed by rotation to a different crop such as wheat, alfalfa, or corn, where the weed can be better controlled with tillage or alternative herbicides to lower the weed populations. Planned crop rotations can reduce weed, insect, and disease problems while improving soil tilth.

## Tillage

Cultivation can be a cost-effective method of controlling weeds before and after planting soybeans. However, intensive tillage systems also increase the risk of soil erosion. Tillage implements that control weeds but maintain surface residues help minimize soil erosion. Cultivation is more effective for weed control with dry soils and sunny conditions than with moist soils and overcast skies.

Use of a rotary hoe after planting can control shallow germinating weed seedlings and alleviate soil crusting problems. Rotary hoes are most effective on small-seeded weeds like crabgrass, foxtail, and pigweed that germinate near the soil surface and are not yet emerged. Large-seeded weeds emerging from deeper in the soil, like cocklebur, velvetleaf, and shattercane, are much less susceptible to a rotary hoe. Some soybean stand may be lost during a rotary hoe operation. Soybeans are most susceptible to rotary hoe injury during the crook stage of emergence.

The effectiveness of between-row cultivation depends greatly on soil conditions, weed and crop size, type of cultivator, and cultivator adjustments. Cultivation rarely provides complete weed control in the row. Cultivation and herbicides can be used together to reduce herbicide costs.

## Herbicides

Herbicides, if used properly, are a safe and effective method to control certain weeds in soybeans. However, herbicides will not solve all weed problems and should be used only as needed in an integrated weed management program. Many herbicides are registered for use on soybeans to control different weeds. Important factors to consider when choosing a herbicide include: 1) weeds present, 2) stage of crop and weed growth, 3) herbicide persistence and crop rotation restrictions, 4) environmental considerations, and 5) herbicide costs.

Knowledge of the weed problems in a field and proper weed identification are essential when making herbicide decisions. Most herbicides selectively control certain weeds when applied as directed on the herbicide label. Weeds not listed on the label probably will not be controlled.

Herbicides are available for early preplant, preplant incorporated, preemergence, or postemergence application to soybeans. Products should only be applied at the recommended application timings to achieve the desired results.

*Early preplant treatments.* Some herbicides can be applied before soybeans are planted in the spring to control emerged weeds or for residual control of later emerging weeds. Emerged weeds must be controlled at planting for soybeans to be successful. If weeds are emerged at treatment time in no-till planted soybeans, a “burndown” herbicide that has foliar activity should be included in the treatment. Many residual herbicides applied early preplant need to be applied before weeds germinate and require precipitation or incorporation for herbicide activation. Early preplant herbicides need enough residual activity to control weeds before and after planting, or else need sequential treatments.

*Preplant incorporated herbicides.* Certain herbicides can be applied and incorporated into the soil before planting to control susceptible weeds. Preplant incorporated herbicides need to be incorporated thoroughly to the proper depth in the soil as directed on the label. Incorporation is more uniform with a dry mellow soil than with a damp or cloddy soil. Avoid

furrowing too deep at planting time and moving too much treated soil out of the planted row, or weed escapes will occur in the row.

*Preemergence herbicides.* Some residual herbicides can be applied to the soil surface after the crop is planted, but prior to soybean and weed emergence. Rainfall or irrigation of about 0.5 inch is required after application to move the herbicide into the soil where it can be absorbed by the germinating weeds. Too little or too much rainfall following herbicide application can result in erratic weed control with preemergence treatments. A rotary hoe or rolling cultivator can be used to control small weeds and help incorporate the herbicide if insufficient rain is received to activate the herbicide.

Preemergence herbicides also can be applied in a band over the row at planting time. Band applications are generally 12 to 14 inches wide with a planned cultivation after crop emergence to control weeds between the rows. Banding reduces total herbicide use and cost.

*Postemergence herbicides.* Several postemergence herbicides are available to control emerged grass and broadleaf weeds in growing soybeans. Application stage, environmental conditions, and adjuvants greatly influence postemergence herbicide performance.

Postemergence herbicides are most effective when applied to small weeds that are actively growing. Application to larger weeds, or plants growing under environmental stress, may result in poor weed control and increased risk of crop injury. Some postemergence herbicides require adjuvants while others do not. Use adjuvants according to herbicide label recommendations.

Always consult the label and follow directions concerning application rates, timing, spray additives, application technique, personal protective equipment, and any other restrictions when using pesticides. For more information on specific herbicide use and weed control ratings, refer to the annual KSU Report of Progress titled *Chemical Weed Control in Field Crops, Pastures, Rangeland, and Noncropland* available at county Extension offices or the KSU Distribution Center.

## Irrigation

---

Irrigated soybean acreage represents about 7 percent of the 3 million irrigated acres in Kansas (Figure 3). Soybeans are a relatively drought-tolerant crop, but respond well to irrigation. Of the 2 million acres of soybeans grown in Kansas annually, the 13 percent that is irrigated give more than 20 percent of the total production. In drought years such as 1991, statewide irrigated yields were almost triple dryland yields. In southwest and south central Kansas, where the majority of soybean production

is on irrigated land, irrigated yield typically is nearly double the dryland yield. Soybeans should remain a viable irrigated crop option because of their good yield potential, favorable economic returns, and value as part of a crop rotation.

### Plant Characteristics

Soybeans are a relatively deep-rooted crop. In deep well-drained soils with no restricting layers, roots can

**Table 10.** Reproductive growth stages of a soybean plant <sup>A</sup>

Stage No.	Abbreviated Stage Title	Approximate Days after Emergence	Description
R1	Beginning bloom	45	One open flower at any node on the main stem.
R2	Full bloom	50	Open flower at one of the two uppermost nodes on the main stem with a fully developed leaf.
R3	Beginning pod	60	Pod $\frac{3}{16}$ inch long at one of the four uppermost nodes on the main stem with a fully developed leaf.
R4	Full pod	70	Pod $\frac{3}{4}$ inch long at one of the four uppermost nodes on the main stem with a fully developed leaf.
R5	Beginning seed	80	Seed $\frac{1}{8}$ long in a pod at one of the four uppermost nodes on the main stem with a fully developed leaf.
R6	Full	95	Pod containing a green seed. Seed that fills the pod cavity at one of the four uppermost nodes on the main stem with a fully developed leaf.
R7	Beginning maturity	115	One normal pod on the main stem that has reached its mature pod color.
R8	Full maturity	125	Ninety-five percent of the pods that have reached their mature pod color. Five to ten days of drying weather are required after R8 before the soybeans have less than 15-percent moisture.

<sup>A</sup> Stages of Soybean Development, ISU Special Report 80.

**Figure 3.** Irrigated crop acreage trends

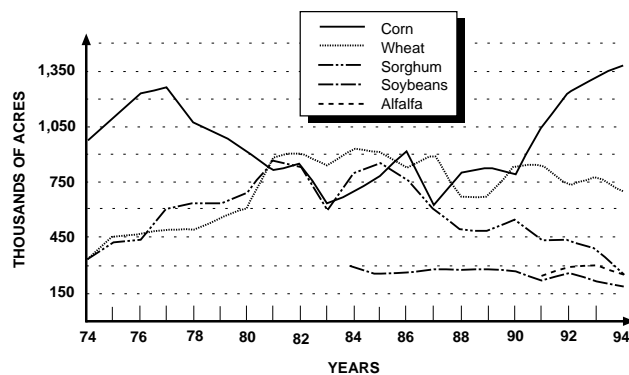

penetrate to 6 feet. However, as with all crops, most of the roots are concentrated in the upper half of the root zone. Managing a root zone of 3 feet is the general irrigation recommendation.

The crop water use requirement, also known as evapotranspiration or ET, for soybeans ranges from 18 to 24 inches total for the growing season, depending on climatic conditions. Water use is generally higher in the west than the east. A value around 22 inches would be a good average estimate for the state.

**Figure 4.** Characteristic growth and water use pattern of soybeans

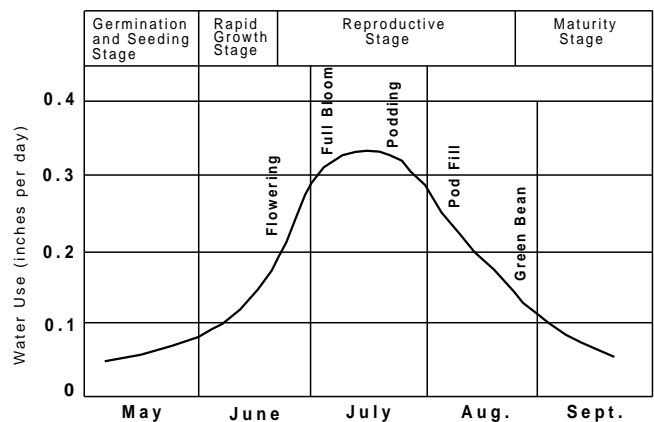

Daily water use varies with the stage of growth and weather conditions. The typical peak water use rate is about 0.32 inches per day, which normally occurs near the beginning of the pod fill stage. Reproduction growth stages are described in Table 10 and noted relative to the water use pattern in Figure 4. Water use is slow at the germination and seedling stages, peaks at or near the full bloom stage, and then declines with maturity. The most

**Figure 5.** Net irrigation requirements for soybeans with an 80-percent chance of rainfall (dry year)

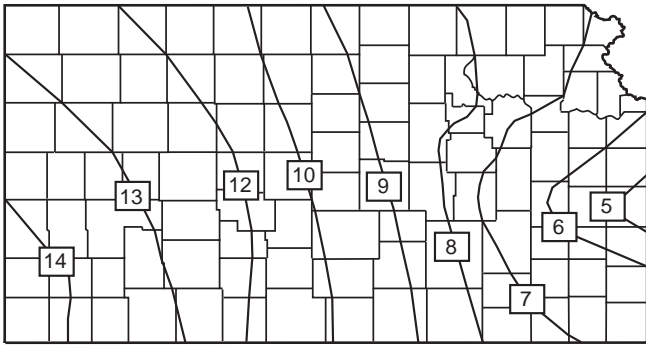

Source: NRCS.

critical time for adequate soil water availability is during the end of the reproductive period when pod fill begins. Soybeans produce many flowers relative to the final number of pods, so losing a few flowers to light water stress earlier in the reproductive cycle is not as critical to final productivity as the same water stress during pod fill.

Net irrigation requirements for soybeans in dry years range from around 14 inches in western Kansas to less than 5 inches in the east (Figure 5). Requirements in an average year will be 2 to 4 inches less (Figure 6).

Various research studies across the state and throughout the High Plains confirm the general rule that the most beneficial timing for a limited amount of irrigation is during the latter part of the reproductive growth stages rather than earlier water. This is generally true because early-season growth and development can be satisfied by typical amounts of rainfall and stored soil water. If full irrigation is possible, 50 to 60 percent allowable soil water depletion should be scheduled. This will allow good utilization of natural rainfall and reduce lodging problems associated with early wet conditions.

Summary research results from Scandia illustrate these general guidelines. Table 11 shows a multiyear comparison for stage of growth and soil water depletion scheduling. Irrigating once during the single late bloom stage shows a yield advantage as compared to a similar amount of irrigation during the early bloom stage and only a slight increase in yield compared to irrigating both during early and late bloom periods. Scheduling by soil water depletion, which does not limit the total season application amount, shows that though irrigating by 60 percent depletion, uses less water, the yields similar to the 30 percent depletion method. The 30 percent depletion also occasionally had increased lodging. In some years, 60 percent depletion had only one irrigation application.

**Figure 6.** Net irrigation requirements for soybeans with a 50-percent chance of rainfall (average year)

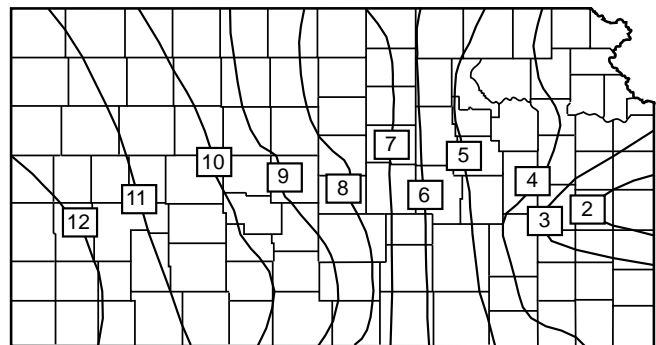

Source: NRCS.

**Table 11.** Irrigation effect on soybean yield (Scandia, Kan., 1974-1980)

Irrigation Treatment	Average Annual Irrigation (inches)	Average Yield (bushels/acre)
Early bloom	3.4	39.4
Late bloom	4.0	42.2
Early and late bloom	7.5	43.1
30% soil water depletion	18.1	52.6
60% soil water depletion	8.0	51.8

Growing season rainfall at Scandia in 1991 was 8.3 inches below the 30-year average. Results from a 1991 soybean trial at Scandia (Table 12), indicated a strong yield increase from a single in-season irrigation as compared to dryland. Yield also increased as the number of irrigations increased. However, the maximum yield of the trial occurred using a 50 percent depletion criteria which used less water than the three-application treatment. Thus, it appears that as more water is applied, scheduling by soil water depletion would be recommended.

**Table 12.** 1991 Irrigation effect on soybean yield (Scandia, Kan.)

Irrigation Treatment	Irrigation Date	Yield (bushels/acre)
No irrigation	- *	19.4
Full bloom	7/18	41.6
Full bloom & mid pod	7/18, 8/1	46.1
Full bloom & mid pod & mid seed fill	7/18, 8/1, 8/18	51.1
50% soil water depletion	7/18, 8/21	51.6

\* Irrigation is approximately 3 inches per event.



Studies at the KSU Northwest Research-Extension Center at Colby used several irrigation scheduling methods and a range of applied irrigation amounts. The results were plotted showing expected yield related to water use (Figure 7). Yield is shown as a percent of test maximum, the value of the 100 percent yield might be considered to be the average of the best soybean test performance in the area. Total water represents the water used by the soybeans plus water losses, which for these studies was primarily percolation below the root zone. The irrigation applied is shown on a second horizontal x-axis and represents the amount of irrigation water required to achieve the total water value.

For western Kansas, a total water use of around 24 inches will result in near maximum yield potential (Figure 7). Over the long term, less water results in lower yields. More water (above 24 inches) does not improve production and may cause inefficient irrigation or loss of natural precipitation. Irrigation amounts of about 11 inches in normal rainfall years would be needed to obtain the maximum yield without wasting irrigation water.

If irrigation water is limited, the irrigator can use Figure 7 as a guide to predict a realistic yield goal for the amount of water available. For example, if only 9 inches of irrigation water can be applied during the growing season in western Kansas, due to either well-capacity or water-right limitations, a realistic long-term yield goal would be 85 to 90 percent of the yield potential. These types of relationships are somewhat easier to establish for western Kansas irrigation conditions since irrigation requirements have less seasonal variations.

Rainfall and soil water-holding capacity are variables that must be taken into account in any irrigation management program. Monitoring soil water or maintaining a record of crop water use is essential for efficient, high yielding production. Scheduling irrigation based on plant growth stage or time of year may produce satisfactory results under normal conditions but frequently

fails to produce the most beneficial results because it does not reflect what is actually happening. Experience is a valuable guide, but new situations occur for which past experience offers no guidance. Under such situations there is no substitute for measurements or estimates of soil water amounts and crop water use rates.

## Medium- and Fine-textured Soils

If the potential root zone is near field capacity of available soil water at planting time, irrigation prior to late bloom or early pod set may not prove beneficial. The available soil water in the top 4 feet of soil will be 8 to 12 inches and should be adequate to supply the plant needs until the late bloom stage if rainfall is near normal. The soybean is quite drought-resistant once it becomes established. Frequently, a single 4-inch application with flood irrigation or a series of smaller applications with sprinklers in the late bloom to early bean-filling stage is all that is needed to supplement natural rainfall.

Growers on the fine-textured soils (clays) of the eastern part of Kansas should be more careful about irrigation. The greater likelihood of rainfall and the slow drainage of these soils can be problems. Irrigation scheduling for these conditions should not allow the soil to saturate, but allow for some reserve soil water storage in case of rainfall. This reduces irrigation costs and prevents drainage problems.

## Coarse-textured Soils

Coarse-textured soils (sands) have a much lower water-holding capacity than the finer-textured soils. Soybeans on sandy soils require much more frequent irrigation because of the low water-holding capacity. Irrigation may be required at any stage of growth with the amount and timing adjusted to the depth of rooting and the weather. Soybeans may require 1 to 2 inches of water every 3 to 7 days during the peak use periods. Sandy soils usually have good to rapid intake rates so they may be irrigated quickly, although some sandy soils in Kansas can crust and present problems with water intake.

**Figure 7.** Soybean water use and applied irrigation vs. yield

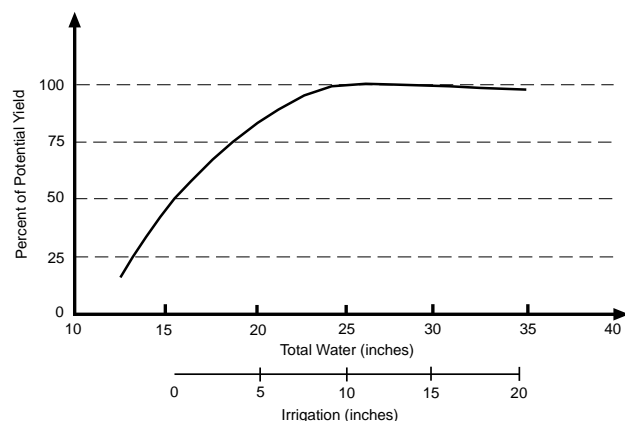

## Water Quality

Soybeans are rated as moderately tolerant to irrigation-water salinity. As a comparison, grain sorghum and corn are rated almost the same (grain sorghum slightly more tolerant, corn slightly less). Wheat is moderately tolerant to tolerant. Alfalfa is rated moderately sensitive. These ratings only serve as a guideline to relative tolerance of crops. Absolute tolerance will vary due to a number of factors including climatic conditions, soil conditions, and cultural practices.

The total concentration of soluble salts in waters can be expressed in terms of the electrical conductivity. This can be measured for the soil water on the irrigation water to be applied. For example, a soil water electrical



conductivity of saturation extracts ( $Ec_e$ ) of 5.5 millimhos per centimeter would cause a yield reduction of 10 percent in soybeans.

The electrical conductivity of the irrigation water ( $Ec_w$ ) that would cause yield reduction is less than  $Ec_e$ . This is because soil water has a salt load due to contact with soil salts. The salt in the irrigation water will be an addition to the amount already in the soil water. Irrigation water with  $Ec_w$  of greater than 2 millimhos per centimeter generally starts to enter a high salinity hazard range. The sodium content of the water also is a concern, but it is not addressed here. The local county agent or agricultural consultant can provide additional information on irrigation-water quality.

Soybeans irrigated using poor-quality water through sprinkler systems may be subject to additional damage when the foliage is wetted by the saline water. Salt accumulates on leaves due to evaporation of water from leaf surfaces, causing premature senescence or leaf drop. During the rapid-growth stage (see Figure 4), replacement leaves are grown; but late in the season early leaf drop can result in severe yield loss.

Irrigation options for poor-quality water are completing all irrigation before all new leaf growth occurs or changing the irrigation system delivery method. Early cutoff of irrigation conflicts with the general irrigation recommendation of late water applications for best yield especially on sandy soils. This option may be possible on soils with high soil water storage capacity. Several

irrigators have attempted to modify their sprinkler packages by equipping sprinkler systems with drag lines. These deliver the water directly to the ground and do not wet the soybean canopy. However, this option must be accompanied by use of appropriate cultural practices to prevent runoff of irrigation water. This may mean use of such activities as maintenance of heavy residue, deep chiseling, furrow diking, or planting in circular rows. These cultural practices increase surface water storage capability and reduce runoff potential. Increasing pivot speed to reduce application depth will also help limit runoff problems.

## Crop Rotation

The potential benefit of crop rotation may be a consideration. From an irrigation stand point, irrigators with limited water supplies usually find soybeans compliment corn irrigation since their critical water period is late in the season verses the earlier critical tasseling period for corn. Often both crops benefit from the rotation. Soybeans also can be used as a late season double crop with wheat.

## Irrigation Summarized

Soybeans are a good irrigated crop option with good yield potential for both full and limited irrigation regimes. Peak daily water use rates for soybeans are about 0.30 inches per day with total seasonal water needs ranging from 18 to 24 inches. Soybeans have an extensive root system and are drought-tolerant. When limited water is available, late season irrigation is generally most important.

---

# Soybean Insects

---

One advantage of growing soybeans in Kansas is the crop is relatively free of serious insect problems. A number of different insects do occur in soybean fields, but few are normally of any economic importance, and the damaging species usually are not abundant enough to warrant control measures.

Since the economics of soybean production dictate that every dollar spent for insect control be fully justified, growers should be relatively sure that yield increases are going to more than pay for the application costs. Insect infestation thresholds have been established to indicate when control measures are actually necessary. The cost of control in a locality, the general condition and stage of crop development, and the expected yield and price of the crop should be considered before a final decision on control measures is made. Poorer growing conditions typically mean smaller plants, so fewer insects are needed to cause economic damage. In very severely drought-stressed situations, yield potential (and profits) may already be so low that further expenses cannot be justified.

Table 13 should help producers identify the major insects. For specific control recommendations, consult *Soybean Insect Management*, MF-743, which is available at county Extension offices and is revised every other year. These publications also are available on the World Wide Web at <http://www.oznet.ksu.edu/library/pub/library/library.htm>.

## Foliage-feeding Insects

Insects that feed on the foliage make up the majority of the insects that attack soybeans. Damage by foliage-feeding insects may occur anytime during the growing season, though light feeding will not affect yield since soybean plants apparently have more leaf surface than required for top yields. Soybeans can more effectively compensate for early stand or foliage loss than for late-season stresses.

Research in various states has shown soybean plants can withstand as much as 35 percent foliage loss during the blooming period. After blooming, when the pods are beginning to form and fill out, any foliage loss greater

than 20 percent will decrease yields. After the beans are nearly mature, a 35-percent defoliation usually will not cause any reduction in yield.

## Pod-feeding Insects

Pod-feeding insects may seriously damage or destroy the beans in the pods. This will lower the yield, especially if infestation occurs late in the blooming period.

## Surveying for Insects

It is almost impossible to walk across a field and evaluate the degree of insect infestation. This is particularly true of insects that attack the pods. The plant-shaking method is a useful tool in surveying soybeans especially when damage is being caused by caterpillars. This requires a heavy piece of white or off-white cloth that measures 24 by 42 inches. A 1-inch strip of wood 24 inches long may be attached to each end of the cloth to make handling easier. A plastic-surfaced material (used vinyl tablecloths work well) will help prevent the dislodged insects from escaping before they have been counted.



To begin the survey, pick a random spot in the field, kneel between the two rows, and unroll the cloth from one row over to the opposite row. It is best at this point to slide the cloth forward so it is positioned under undisturbed plants. Place your arms around approximately 18 row-







inches of plants on each side of the row and vigorously shake the foliage over the cloth. Most of the insects should fall into the cloth where they can be counted. The number counted in one sampling location represents the number of insects present on 3 feet of row.

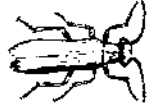



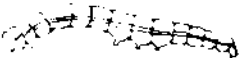

A total of 10 random sites should be sampled across the field, and the total numbers of each economic species should be recorded. Compare the numbers sampled with the treatment thresholds listed in Table 10. Remember these guidelines may vary somewhat from field to field. For instance, control is probably not warranted for caterpillar-type pests if most have finished feeding and are pupating (the damaging period is nearly past and little will be gained by “revenge” treatments).

Very active insects (grasshoppers) or very tiny insects (thrips) cannot be sampled with a shake-cloth. To estimate grasshopper populations, walk across the field, visualize square yard units ahead, and count the grasshoppers that leave the area as you walk through it. The need for treatment for thrips is based on visible plant injury and relative counts of thrips. Plants heavily attacked by thrips often have lower leaves that turn brown, shrivel, and die. Lower surfaces appear somewhat silvery as a result of the feeding damage. Damage is usually heaviest adjacent leaf veins. Tiny, black spots (waste products) cover the lower sides of the affected leaves.

**Table 13.** Insects and mites commonly found in Kansas soybeans

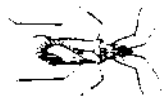
INSECT	DESCRIPTION	SYMPTOMS & INJURY	TREATMENT THRESHOLD
 <p><b>Seed Corn Maggot</b></p>	White maggots in seed planted in high organic matter soil or wet conditions. Adult is a small fly. Several generations occur each spring.	Seedlings fail to emerge or primary growing point is destroyed and a “Y-plant” develops when the plant compensates by branching at the cotyledons.	If stand loss is severe, replanting may be advisable, possibly with seed treated with a protectant.
 <p><b>Bean Leaf Beetle</b></p>	Background color varies, usually a light tan-to-reddish brown beetle with 4 to 6 black spots on back. Back usually margined with black. Body is longer than wide.	Foliage feeder, small oval leaf holes. Can transmit bean pod mottle disease. Defoliation only important early in the season under most conditions. May feed on blossoms or pods late in the season (usually of little consequence in Kansas).	Treatment usually justified if severe cotyledon feeding, threatened destruction of the growing point, or more than 25% defoliation (typically requiring 7 or more beetles per foot of soybean row and plants with 4 or fewer nodes). Treat to stop bean injury when one pod per plant is damaged on 50 to 60% of the plants.
 <p><b>Mexican Bean Beetle</b></p>	Adult looks like a ladybug, yellow to orange with 16 black spots on the back. Oval-shaped body. Larvae yellow, and covered with branched black spines.	Foliage feeder, small holes and a lacelike “skeletonized” appearance typifies injured leaves.	Rarely found in Kansas. Historically, most commonly reported in far eastern counties.
 <p><b>Blister Beetle</b></p>	Long cylindrical body, usually 3/4 inch or more. May be striped or solid color. Thorax always narrower than rest of body.	Foliage feeder. Beetles tend to aggregate in small areas of the field. Foliage stripped from plants when high populations develop.	Seldom is more than spot treatment justified. More important as a toxic (to horses) hay contaminant in alfalfa.

INSECT	DESCRIPTION	SYMPTOMS & INJURY	TREATMENT THRESHOLD
<b>Fall Armyworm</b> 	<p>Caterpillar with five fleshy prolegs, no "microspines," dark brown body with variable markings. Rear of abdomen has four black spots at the corners of an imaginary square. Head capsule black with an inverted white-lined Y on front (not always well-defined).</p>	<p>Foliage feeder. Causes ragged appearance to plants. Most common from July through September.</p>	<p>Most noticeable in late-planted weedy fields. Treatable problems very uncommon.</p>
<b>Garden Webworm</b> 	<p>Caterpillar with five fleshy abdominal prolegs. Three black spots occur on each side of each segment. Green to yellowish-green in color. Larvae move backwards rapidly when disturbed.</p>	<p>Foliage feeder. Webbing of leaves very evident. Caterpillars stay within webbed leaves, feeding often causes leaves to turn brown as they dry out from the injury.</p>	<p>Heavy infestations are most serious on younger plants. Treat when more than 10 to 12% of plants show significant webbing. Penetration of webbing requires adequate pressure and gallonage (minimum 30 psi and 10 gpa).</p>
<b>Green Cloverworm</b> 	<p>Caterpillar with four fleshy abdominal prolegs. Solid light green with a faint white stripe down each side of the body. Larvae flip violently to escape the source of the disturbance when touched.</p>	<p>Foliage feeder. Attacked leaves look "ragged." Feeding heaviest in the upper part of the canopy. Eastern Kansas especially, May through August. Serious populations stripped virtually all foliage in some fields in late summer of 1995.</p>	<p>Control probably not necessary if some larvae are beginning to die from a fungal disease (turning white or velvety green). Otherwise treat if 9 to 16+ larvae per foot of row. (For details see the Extension publication, <i>Soybean Insect Management Recommendations</i>.)</p>
<b>Cabbage Looper</b> 	<p>Caterpillar with three abdominal prolegs. Solid green with a faint white stripe down each side of the body. Tapers slightly toward the head.</p>	<p>Foliage feeder. Occasionally found feeding in Kansas soybeans. Ragged leaves.</p>	<p>Significant populations rarely develop in Kansas soybean fields.</p>
<b>Grasshopper</b> 	<p>Various species. Immature nymphs and adults have enlarged hind legs and jump when disturbed. Several different types and color patterns exist.</p>	<p>Foliage feeders. Ragged leaf tattering, usually starting from the edge of a leaf. Damage occurs from June through September.</p>	<p>Edge treatment more common than field-wide sprays. Treat field margins when 20 per square yard are found. Field treatments may be needed when numbers exceed 8 per square yard.</p>
<b>Painted Lady</b> 	<p>Black caterpillar covered with branched black spines. Yellow spots often evident across the back. May reach 1.5 inches long. Adult is a common (orange/black/white) thistle-loving butterfly somewhat smaller than a Monarch.</p>	<p>Foliage feeder. Spins a "canopy" of webbing over the leaves it is feeding on. Typically rolls the edges of one or more leaves together, securing them with silk. Migrates in from the deserts of the southwest.</p>	<p>Probably most important early in the season. Treatment justified if more than 2 larvae per foot of row are found on young soybeans. Evaluate late-season defoliation damage by using the percentage loss estimates presented under "Foliage-feeding Insects."</p>

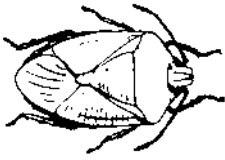
INSECT	DESCRIPTION	SYMPTOMS & INJURY	TREATMENT THRESHOLD
<b>Thrips</b> 	Very tiny insects that move swiftly across the lower surface of leaves, zigzagging around leaf hairs. Most commonly noticed adjacent to leaf veins. Winged and wingless forms may be found.	Very tiny white or silvery streaks show up on the lower side of attacked leaves. Typically heaviest damage right against the leaf veins, but entire surface may be damaged. Many small black spots (excrement) may be present.	Most serious where drought or other stress weakens the crop. Treatment may be justified if leaf damage causes severe injury or death in a significant portion of the leaves and thrips are very numerous.
<b>Insidious Flower Bug &amp; Minute Pirate Bug</b> 	Small black and white insect (1/8 inch). Adult resembles a tiny adult chinch bug. Nymph is pale orange and elliptical in shape.	Predator. Kills other pests by sucking the contents out of insect eggs and destroying newly hatched larvae. Does not damage plants.	Beneficial. DO NOT spray specifically to control this insect.
<b>Nabid</b> 	Small, tan-to-dull brown bug (1/4 to 3/8 inch) with grasping prelegs and a slender beak that folds back beneath the straight-sided body.	Predator. Kills other pests by sucking out their fluid contents. Manipulates prey with grasping forelegs. Does not damage plants.	Beneficial. DO NOT spray specifically to control this insect.
<b>Lacewing Larva</b> 	Somewhat alligator-shaped larva equipped with long, curved, hollow mandibles. Usually tan-gray in color.	Predator. Mandibles used to hold, puncture, and suck out the contents of captured prey. Does not damage plants.	Beneficial. DO NOT spray specifically to control this insect.
<b>Lady Beetle</b> 	Yellow or red adults usually with black spots. Larva alligator-shaped; typically red/blue/gray-black markings. Eggs yellow.	Predator. Kills and eats small pest insects and/or eggs. Most effective against aphids.	Beneficial. DO NOT spray specifically to control this insect.
<b>Spider Mites</b> 	Very, very tiny (1/50 inch) insect relative. Adults have 8 legs, immatures 6 legs. Moving pinpoint on white paper.	Foliage looks "stippled" initially, eventually turning bronze. Lower leaf surface may be covered with a fine webbing that is crawling with "moving specks." "Bronzed" areas in a field often start in localized areas and progress in an elliptical or circular area across the field.	Foliage loss progressing rapidly up the plant. Especially critical as the plant approaches pod-fill. Directed sprays should thoroughly cover undersides of leaves.
<b>Spotted Cucumber Beetle or Southern Corn Rootworm</b> 	Green to yellow, black-spotted beetles. Relatively soft-shelled.	Small, roundish holes chewed in the leaves.	Not economically important. Do not treat.
<b>Stink Bug</b> 	Shield-shaped bugs, green and brown, 5/8 inch in length. Mouthparts formed into a SLENDER beak in most plant-feeding species. Immature bugs of various colors, closely resembling adults in shape but more rounded and without wings.	Inserts piercing-sucking mouthparts through pod wall into developing seeds. Feeding lowers seed quality and quantity. The southern green stinkbug most common in southeastern Kansas.	Only spot treatment or border treatment may be necessary. Sprays justified when an average of 10 plant-feeding bugs per 30 feet of row are found.



INSECT	DESCRIPTION	SYMPTOMS & INJURY	TREATMENT THRESHOLD
<b>Corn Earworm</b>  	Caterpillar with five fleshy prolegs below the abdomen. Tiny "microspines" visible through a hand lens. May feel rough when rubbed slightly across the finger. Yellowish-brown head capsule with network patterning present typically. Body color varies widely.	Important as a pod feeder. Larvae feed through pod wall to damage or consume beans. Leaf-feeding usually incidental as small worms develop in size. September occurrence.	Large worms difficult or impossible to control. Treatment justified when an average of 30 worms (preferably less than 1/4 inch long) per 30 feet of row are found. Full-grown worms 1 1/4 inch long.

## Soybean Diseases

Except for charcoal rot and soybean cyst nematode (SCN), soybean diseases normally do not result in major yield losses under Kansas growing conditions. From time to time however, weather and growing conditions can combine to produce significant losses from diseases such as *Phytophthora* root rot, seedling blights, and *Phomopsis* pod and stem blight.

### Disease-free Seed

As with any crop, a healthy soybean field begins with high-quality, disease-free seed. Certified seed, while not guaranteeing freedom from disease, is usually preferable to bin-run seed since, among other things, it is required to meet minimum germination standards. It is particularly important not to save seed from fields infected with pod and stem blight, purple seed stain, bud blight, or soybean mosaic. These diseases can be transmitted either on the surface of or inside the soybean seed. Also, seed that is cracked or broken is more easily invaded by seedling disease organisms than sound seed. Care should be taken in harvesting and handling to reduce mechanical damage.

### Crop Rotation

Since many soybean diseases such as pod and stem blight, brown spot, and bacterial blight can overwinter in infested crop debris, rotating soybeans with nonhost crops such as corn, sorghum, or wheat is a sound disease control practice. Other soybean diseases, such as *Phytophthora* root rot, charcoal rot, and SCN, can persist in the soil for several years making crop rotation less effective. Even in these cases, rotation will help to suppress the disease and limit yield losses.

### Seed Treatment

(see also *Seedling Diseases*, pg. 24)

Soybean seed should not be planted when standard tests show germination is below 85 percent or vigor is low. If such seed must be planted, a seed treatment is

usually recommended. For higher quality seed, seed treatment in Kansas is not economical unless conditions at planting time are unfavorable for rapid germination and emergence. Soil temperatures lower than 60 degrees Fahrenheit will inhibit soybean growth and promote seed rot and seedling damping-off, particularly if soils remain wet. Other soil factors affecting emergence are soil type, crusting, depth of planting, and herbicide usage.

Seed treatment fungicides can be divided into two general categories: contacts and systemics. Contact fungicides will only control those fungi on the outer surface of the seed. Systemic fungicides, on the other hand, are absorbed into the germinating seed and will provide additional protection as the plant emerges. Contact fungicides used as seed treatments include Thiram and Captan. Commonly used systemic fungicides include Vitavax, Agrosol, and Rival. A fungicide specific for the control of *Phytophthora* and *Pythium* diseases is Apron. This product is specific to these two diseases and should be applied in combination with other seed treatment products if a broader spectrum of control is needed.

Use higher rates of *Rhizobium* inoculum if treating seed with fungicide, because prolonged contact with fungicides may damage the inoculum. For best results, treat seed ahead of planting, then inoculate at planting time. Alternatively, both seed treatment and inoculum may be applied at planting.

### Foliar Fungicides

Kansas State University does not routinely recommend sprays for the control of foliar soybean pathogens because research has shown them to be ineffective in Kansas for increasing yields. Foliar sprays, however, have been shown to improve seed quality in years when warm weather and frequent rains during the reproductive phase of soybean development favors the growth of the pod and stem blight organism. In Iowa, it has been shown that one fungicidal spray at growth stage

R6 (pods just visible at one of the four uppermost nodes) was effective in controlling *Phomopsis* seed decay. The fungicides Benlate, Topsin-M, and Mertect 340-F are labeled for control of foliar soybean diseases.

## Seedling Diseases

Seedling disease refers to a large group of soil- and seed-borne organisms that attack the soybean seed prior to germination or the plant during the early stages of growth. Symptoms for all of the organisms are similar. They include seed rot, pre- and postemergence damping-off (a constriction of the stem at or below the soil line), and yellowing and stunting of young seedlings. Situations favoring disease development include poor quality seed and adverse growing conditions caused by wet soil, compaction, or cold soil temperatures (less than 60 degrees Fahrenheit). Management practices include using high quality seed, planting when conditions promote rapid emergence, planting at the correct depth, and avoiding herbicide damage. In certain situations, seed treatments may be effective.

## Fungal Diseases of Roots and Lower Stem

**Charcoal Rot.** The fungus causing charcoal rot survives in the soil and directly infects the roots. Severe losses occur frequently on nonirrigated soybeans, especially during hot, droughty periods. The disease is most common in eastern Kansas. Plants turn yellow and die slowly, but leaves remain attached. The symptoms are easily confused with drought stress. Small, black, fruiting structures known as sclerotia form on the lower stem and in the pith. Any management practice that promotes moisture conservation (reduced planting rates, no-till, weed control, irrigation, etc.) will reduce losses. All varieties are susceptible, but late-maturing varieties are more tolerant than early-maturing varieties.

**Phytophthora Root Rot.** *Phytophthora* may occur any time during the season if soils remain wet. The fungus survives in soil and produces swimming spores that infect roots. *Phytophthora* symptoms include pre- and postemergence damping off. Older plants may turn yellow and leaves may wilt. Roots usually appear rotted and a brown discoloration extends from the soil line up into branches and petioles. Conditions encouraging disease include poorly drained soil, flooding from heavy rains, or overirrigation. Resistant or tolerant varieties are the best means of management. There are many races of *Phytophthora* and varieties should be selected accordingly. Any improvements in drainage also will help. Chemical control is available. Apron seed treatment will protect plants against early infection. Ridomil, applied in the furrow at planting, will provide protection well into the growing season.

**Pod and Stem Blight.** Yield losses from this disease are infrequent, but seed quality can be greatly reduced. The fungus survives in diseased stubble or is seed-borne. At maturity, symptoms appear as vertical rows of small black spots on the stem or pods. Seeds may be cracked, shriveled, or moldy. The disease is favored by high humidity and rainfall, especially late in the season. The disease can be managed using crop rotation, destruction of infested debris, or chemical treatment. Seed treatments can be used on pod and stem blight infested seed. Foliar sprays may be used on soybeans grown for seed at growth stage R6.

**Stem Canker.** Stem canker is rarely a problem in Kansas, but it is easily confused with *Phytophthora* root rot. The fungus survives in stubble or can be seed-borne. Spores are windblown or water-splashed onto plants. Sunken, brownish cankers with dark brown margins form on lower nodes with green stems above and below the canker. The canker is usually on one side of the stem but can girdle the stem causing the upper portion of the plant to wilt and die. Crop rotation, removal of debris, and use of tolerant cultivars aid in management.

## Fungal Diseases of Foliage, Upper Stems and Pods

**Brown Spot.** This disease is very common early in the season but seldom persists until maturity, and yield losses are small. It is seed-borne or survives in crop residue. The disease can spread rapidly through a field by the blowing and splashing of spores. Angular brown spots form on leaves. Later, the leaves turn yellow and drop, giving the lower plant a barren appearance. The disease is most common in humid areas where rotation is not practiced. Crop rotation, removal of debris, and planting disease-free seed are recommended management practices.

**Downy Mildew.** Light infections are frequent in Kansas. Severe infections are rare but can occasionally result in smaller seed size, low test weight, and poor quality. The fungus can survive on infested leaf debris and on seeds. Spores are spread by wind or rain splashing. Symptoms appear as pale green to light yellow spots. On the lower surface, tufts of grayish mildew develop. Some leaves may yellow and drop. The seed and inner pod surface may be coated with whitish mold without exterior pod symptoms. The disease is favored by high humidity and cool temperatures. Young leaves are most susceptible and late plantings usually have more disease because spores are more abundant. Management is achieved by crop rotation and using resistant varieties.

**Purple Seed Stain.** Seed infection takes place when rain occurs during flowering. There are no foliar symptoms. Seeds are stained with a purplish-brown color, reducing quality. Disease management includes planting disease-free seed, using resistant cultivars, and seed treatment.



## Bacterial Diseases

**Bacterial Blight.** This disease occurs in most fields, but rarely is moisture consistent enough for losses to occur. Bacteria are seed-borne and survive in crop residue. Bacteria are commonly spread during storms containing high winds and heavy rains. Symptoms include small, water-soaked leaf spots that turn brown and have a yellow border. As spots coalesce, the tissue falls out giving the leaves a torn and ragged appearance. Do not save seed from severely infected fields. Crop rotation and avoiding field operations when the foliage is wet are important management tools.

**Bacterial Pustule.** This disease is very similar to bacterial blight. The key diagnostic feature is the development of raised pustules in the center of lesions on the under side of the leaf. This disease generally develops later in the season when temperatures are warmer. Some resistant cultivars are available, otherwise management is the same as for bacterial blight.

## Viral Diseases

**Bud Blight.** Caused by tobacco ringspot virus, this disease is occasionally present in low incidence. If abundant, do not use the crop for seed. The disease is easily transmitted mechanically. Immature thrips also may vector the disease. Many weed hosts can serve as reservoirs for the disease. Infected plants are dwarfed. The pith in the upper nodes turns brown. Pods may develop brown blotches and seed development may be inhibited. There is often a distinct curling of the uppermost stem tip. Infected plants often remain green until frost occurs. Management of the disease includes using disease-free seed, controlling weeds in and around the field, and roguing of infected plants.

**Soybean Mosaic.** This is the most common virus disease in Kansas. The limited frequency of aphid flights in Kansas may limit the disease. Several aphids (but not the greenbug) transmit the virus. Most infection comes from planting infected seed. Leaves are crinkled, yellowish, and strapped in appearance. The disease is often confused with 2,4-D injury. Plants remain green until frost. The seed is often discolored, especially around the hilum. Management techniques are the same as for bud blight.

## Nematode Diseases

**Soybean Cyst Nematode.** This disease has rapidly spread in recent years. It can be spread by infested soil on equipment or migrating water fowl. Seed grown in infested areas containing soil peds can also spread the disease. Plants are often stunted and yellow with reduced nodulation. Symptoms are easily confused with drought, flooding, herbicide injury, compaction, or nutrient deficiency. Frequently, the only symptom is a gradual production decline in a field over time. Crop rotation and the use of resistant varieties are the keys to management. Several races of the nematode occur in Kansas so rotating the sources of resistance in varieties is also important.

**Sting Nematode.** This disease is a problem only in the sandy soils of the Arkansas River basin. The nematode feeds at the growing points of the roots, giving them a pruned appearance. The nematode injects a toxin as it feeds, causing the root tips to become necrotic. Above ground, severe stunting is the most frequent symptom. Rotation with a nonhost crop is the primary management recommendation.

# Harvesting Soybeans

---

Field studies in soybeans have shown that 4-bushel-per-acre machine losses are not uncommon. Field experiences and research studies have shown machine losses of soybeans can be reduced to less than 1 bushel per acre. The results of a 1989 study conducted at The Ohio State University found the average machine loss in soybeans was 1.4 bushels per acre, but the highest loss was 4.1 bushels per acre. About 40 percent of the operators studied had losses less than 1 bushel per acre, while almost 20 percent had losses exceeding 2 bushels per acre. To reduce losses, combine operators need to know where harvesting losses occur, how to measure losses, what reasonable levels of loss are, and the equipment, adjustments, and operating practices that will help reduce losses.

## Where Losses Occur

Soybean losses can occur before harvest as preharvest loss or during harvest as machine loss. Preharvest loss can be high, and it can only be minimized by harvesting in a timely fashion. Machine loss can occur at several places in the combine, but the most common for soybeans is at the header. Cleaning and separating losses are generally minimal compared to gathering loss. Soybeans are fragile and shatter easily, so close attention should be paid to header adjustments and operation.

## Measuring Harvest Losses

It is necessary to have a means to enclose an area of 10 square feet that is representative of the entire swath

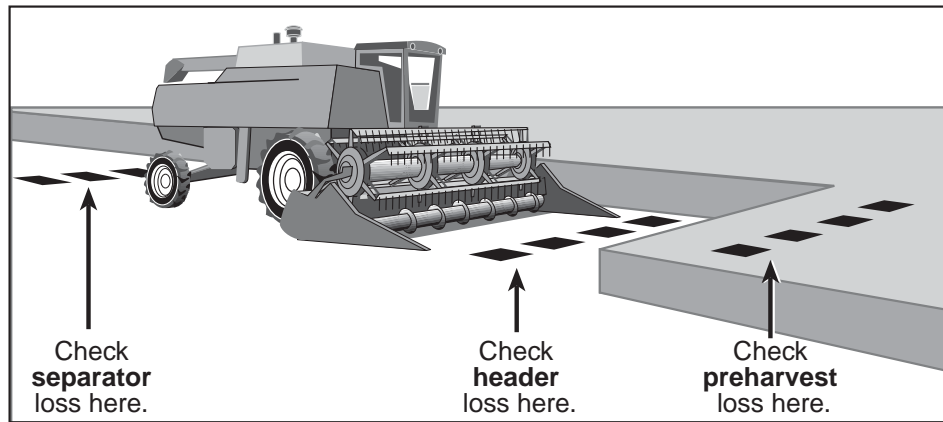

**Figure 8.** Measuring soybean harvest losses

width. For narrow platforms or heads this is probably most easily done by using a continuous strip across the full cutting width of the machine. For large platforms, it may be easier and more suitable to count only in selected areas, such as every other row, across the width of the machine. In any case, the important part is obtaining a representative sample. Rigid frames can be made from heavy wire or rod. Flexible frames can be made from plastic clothesline and wire stakes in the corners.

#### Examples of frames and usage:

- 12-foot platform: 10-inch by 12-foot frame across entire width of cut.
- 15-foot platform: 8-inch by 30-inch frame used six times across entire width of cut (this still encloses a continuous strip).
- 20-foot platform: 12-inch by 30-inch frame used four times across entire width of cut (every other row in 30-inch rows).

### Loss Measurement Procedure

This procedure is designed to minimize the time and effort required to check harvesting losses (Figure 8). Ground counts are taken only as required.

1. **Determine total loss:** Operate combine under typical operating and field conditions. Stop the combine and back up about 20 feet. In the harvested area behind the combine, count the beans in a 10 square foot area across the entire swath width and enter this count in the loss data table. Divide this number by 40 and enter the loss in bushels per acre. If the total loss is less than 3 percent of yield, keep harvesting. If loss is greater than 3 percent, continue this procedure to pinpoint the source of loss.
2. **Determine preharvest loss:** In the unharvested area in front of the combine, count loose beans on the ground and beans in pods lying loose on the ground in a 10-square-foot area across the entire width of cut. Enter this count and then divide by 40 to get loss in bushels per acre.

3. **Determine machine loss:** Machine loss is calculated by subtracting the preharvest loss from the total crop loss. If machine loss is less than 3 percent of yield, keep harvesting. If machine loss is more than 3 percent, proceed to check gathering unit losses.
4. **Determine gathering unit loss:** In a 10-square-foot area across the entire width of cut in front of the combine, count and categorize beans according to the type of loss below. Gathering unit loss is the sum of these four losses.

*Shatter loss:* Loose beans on the ground and beans in loose pods on the ground minus the preharvest loss count.

*Loose stalk loss:* All beans in pods attached to stalks that were cut but not gathered into the machine.

*Lodged stalk loss:* All beans in pods attached to soybean stalks that were lodged and are still attached to the ground.

*Stubble loss:* All beans in pods still attached to stubble.

5. **Determine cylinder and separation loss:** Subtract the gathering unit loss from the machine loss. Compare harvest loss levels to goal loss levels. Concentrate on machine adjustments and operating practices that will give the least total loss.

### Gathering Equipment

Several machinery developments have improved gathering efficiency over that of a conventional cutter-bar platform in soybeans. Some of these are the add-on flexible-floating cutter bar, the integral flexible-floating cutter bar, the row crop head, and the narrow pitch cutter bar.

Tests in Illinois in 30-inch rows showed header losses averaged 8.7 percent of the total yield with an add-on flexible-floating cutter bar, 3.8 percent with an integral flexible-floating cutter bar, and 1.4 percent with a row-crop head. These tests indicate an advantage of the integral flexible-floating cutter bar over the add-on. The row crop head seems to have a clear advantage over both cutter bar arrangements in these tests.

Tests in Louisiana compared an integral flexible-floating cutter bar to a row-crop head in 40-inch rows. The average harvest losses were 3.4 percent with the integral flexible-floating cutter bar and 3.0 percent with the row crop head. Additionally, tests were run with the integral flexible-floating cutter bar in 7-inch rows and 30-inch rows to determine the effect of row width on harvest losses. The average losses were 1.4 percent in 7-inch rows, 2.2 percent in 30-inch rows, and 3.4 percent in the 40-inch rows as previously stated. These tests did not show the clear advantage of the row-crop head over the integral flexible-floating cutter bar that the Illinois tests did in a direct comparison. If the narrow rows are considered, it appears harvest losses would be lower with the integral flexible-floating cutter bar.

Other tests have shown narrow-pitch (1.5-inch) cutter bars typically have about two-thirds of the gathering losses that occur with the standard 3-inch-pitch cutter bars. Narrow pitch sections and guards can be ordered as optional equipment on some models or obtained from aftermarket companies.

The data given here should indicate representative losses with various gathering units in standing crop conditions. An important factor not addressed here is harvesting under adverse conditions, mainly lodging. Tests have not been done in soybeans to determine losses with different gathering units under various degrees of lodging.

Although specialized gathering equipment for soybeans can significantly reduce harvesting losses, there is the cost factor to consider to make sure the equipment is economically justifiable. Some key factors in this decision are acreage farmed, present machinery, and other crops. The flexible-floating cutter bar will work in wheat and grain sorghum. The row-crop head works well in grain sorghum in rows. A comparison can be made to see if the improved gathering efficiency would justify an additional investment in some of the specialized gathering equipment for soybean harvesting.

## Combine Adjustment and Operation

Reel speed and position are extremely important in harvesting soybeans. The reel should be positioned for minimum disturbance of standing plants. Reels with pick-

up fingers will cause the least disturbance to the standing plants. When the reel is positioned properly, the soybean plants will be conveyed smoothly across the cutter bar, along the auger, and into the combine feeder.

Gathering losses are minimized when the reel speed is set about 25 to 50 percent faster than ground speed. A 42-inch reel should rotate at about 12 rpm for each 1 mph of ground speed. The reel will shatter beans excessively if it turns too fast, and too many stalks may be dropped or recut if it turns too slowly. Position the reel 8 to 12 inches ahead of the sickle. A bat reel should be operated just low enough to tip the stalks onto the platform.

One of the more important items to check is the separator speed. Each combine has one particular shaft as the starting point for checking operating speed. If the separator is not running at the proper speed, it will reduce the efficiency of the cleaning and separating units. It will be difficult to clean soybeans and minimize losses.

Before the combine goes to the field, there are a number of other adjustments that should be made using the operator's manual as a guide. These include cylinder speed, cylinder-concave clearance, sieve settings, and fan adjustment. If the operator's manual is followed closely, the operator usually needs to make only minor adjustments in the field.

Seed damage is affected more by cylinder speed than by cylinder-concave clearance. It is important to reset the cylinder speed as conditions change throughout the day and the harvest period. Tests have been conducted to compare seed quality with rotary and conventional threshing combines. Percentage of splits with the rotary machines was typically half or less of the splits with the conventional machines. However, both types of machines have the capability to harvest with less than the 10-percent limit of splits for U.S. No. 1 soybeans.

If weedy conditions are encountered during harvest, especially when weeds are green, reduce travel speed to maintain low threshing and separating losses. Do not increase cylinder speed because this will only cause excessive damage to the beans and put more trash in the grain tank.

# Drying and Storage

---

## Drying Considerations

Soybeans can be harvested at 16 to 18 percent moisture content without damage if the plants have frosted or died. The beans must be dried to less than 14-percent moisture content before storing. Germination is reduced when seed

beans dry and rewet several times before harvesting. Drying systems used for corn or grain sorghum are adaptable to soybeans. Soybeans are fragile and can be damaged by air that is too hot or too dry and by rough handling. Three common methods for drying soybeans are natural air, low temperature, and high temperature.

Natural air involves moving unheated outdoor air through a bin of soybeans. Only one to two points of moisture can be removed with a natural air drying system. Little natural air drying occurs unless outdoor air temperature is greater than 60 degrees Fahrenheit and relative humidity below 75 percent. The successful use of unheated air depends on the available airflow rate per bushel of beans and favorable weather conditions. If the soybeans can be dried, their quality is excellent unless there is handling damage. Bins should be equipped with a full perforated floor and fan unit. Fans capable of delivering 1 to 2 cubic feet of air per minute per bushel of soybeans (cfm/bu) are required.

Low-temperature drying is similar to natural air. Low-temperature drying can be used when drying soybeans for seeds and is best suited when only three to four points of moisture are removed. The outdoor air is heated 5 to 20 degrees Fahrenheit with low-temperature drying. This reduces the humidity of the drying about 10 to 20 percent. Bin depth is limited to 16 feet and air flow rates are 1 to 2 cubic feet per minute per bushel. The humidity of the drying air should range from 40 to 70 percent.

High-temperature dryers, such as batch dryers, continuous-flow dryers, or in-bin dryers, can be used to dry commercial, those used for oil or meal, but not seed soybeans. It is recommended the maximum drying air temperature be limited to 140 degrees Fahrenheit. If quality (few splits or no change in the oil's free fatty acid content) is important, the drying process should be controlled by maintaining the relative humidity greater than 40 percent rather than controlling temperature. Drying temperatures greater than 110 degrees Fahrenheit and 140 degrees Fahrenheit will affect germination and oil content, respectively. Excessive heat decreases the drying air relative humidity, which causes damage to the seed coat or pericarp cracking and results in splits. Seed coat cracking and splits

may occur if the relative humidity of the drying air is less than 40 percent. Split soybeans are more susceptible to mold and fungi invasion than whole beans.

## Storage Considerations

Beans must be uniformly dried at less than 14 percent if stored less than 6 months and 11 percent for longer storage. Good-quality, clean soybeans can be stored at higher moisture content than damaged beans. The storage moisture content is dependent on the temperature, moisture content, length of storage, and soybean quality (Figure 9).

Storage problems often can be traced to areas where pockets of foreign material, fines, or weed seeds have accumulated. Such pockets provide a place for insects and molds to live, and they inhibit effective aeration and fumigation. Excessive foreign material and fines restrict the airflow through the soybeans. Spoutlines can contain up to 80 percent weed seeds. Germination losses of seed soybeans is more likely due to pockets of excessive splits and foreign material rather than unsafe average storage temperatures and moisture. These pockets of material tend to be at higher temperatures or moisture contents. Molds and fungi are able to grow and invade viable beans in these pockets and kill their germination. These dead seeds are then mixed with viable soybeans, so the average germination is reduced.

Good storage management can greatly influence the storability of soybeans. Information on grain protectants and fumigants and bin wall sprays for use with soybeans can be obtained from the area or state Extension entomologist or county Extension agents. Successful storage of soybeans involves sanitation, aeration, and monitoring (SAM).

Sanitation ensures soybeans are harvested, transported, and handled with clean equipment and stored in a clean structure. Combines, transportation equipment, and conveying equipment should be cleaned of infested soybeans or other grains before harvest. Sanitation in storage structures involves sweeping, cleaning, and removal of old soybeans or grains both inside and outside the storage structure. To avoid contaminating newly harvested beans, remove and destroy leftover debris from bins and sweep down the walls, ceilings, sills, ledges, and floors.

Trash, old machinery, and litter around the bin areas should be removed. No vegetation should be within 2 feet of the storage structure. Another source of infestation is the spilled grain around the loading and unloading equipment. A weatherproof seal or other bin repairs, particularly where side walls join the floor and roof, are needed to prevent moisture or rodents from entering the storage structure.

Soybeans, at 14 percent or less, stored for more than 3 months should be placed in a bin equipped with an aeration system. Aeration is reducing the temperatures

**Figure 9.** Safe storage time for soybeans (seed) based on an 80-percent germination

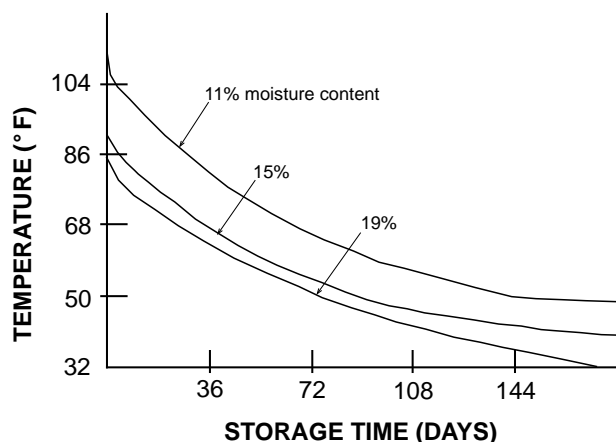



inside a bin to 40 degrees Fahrenheit using outside air. Aeration controls grain temperature to prevent spoilage, mold and insect activities, and moisture migration. This is accomplished by an aeration system that provides a reasonably uniform airflow of about 0.1 to 0.5 cubic feet of air per minute per bushel or a drying system.

Aeration is not a drying process although small moisture changes do occur with a change in temperature. During aeration (cooling or warming) a temperature zone moves through the beans much like a drying front during drying, only much faster. It is recommended to begin aeration immediately following harvest to remove field heat and equalize temperatures within the storage structure. Aeration fans can be controlled manually or with controllers. The electronic controllers can be used with natural air or low-temperature drying operations and aeration. Simple thermostatic controllers can only be used with aeration. Aeration controllers typically will reduce the average temperatures in a bin 4 to 6 weeks quicker than manual operation. This time difference is dependent upon whether the beans are harvested in early or late fall. Electronic controllers have several management strategies to choose from depending on moisture content, temperature, and storage time.

Soybeans should be maintained at 40 degrees Fahrenheit during the winter and 50 to 60 degrees Fahrenheit during the summer. To cool the beans in the fall, the average outside temperatures (average of high and low for a day) should be 10 to 15 degrees Fahrenheit less than soybean temperatures. The fan should run continuously until the beans are completely cooled unless a controller is used. At 0.1 cubic feet of air per bushel, the fan will have to run about 120 hours to move a cooling cycle through the bin. However, to be sure the beans are cooled, the temperature of the beans should be measured at several points within the bin.

Frequent monitoring or observation is the best way to detect unfavorable storage conditions. The soybeans should be checked weekly from April to November and biweekly from December to March. Operating a fan for about 20 minutes during monitoring helps determine the conditions. Be observant for odors, steam, water vapor, heat, and moisture condensation while the fan is on. A faint musty odor is often the first indication of spoilage. This is particularly true during the spring when heating may be occurring due to warm weather or molds and insects. If steam, water vapor, or heat is observed, the soybean quality has deteriorated. The aeration fans should

be turned on immediately to recool the soybeans and then market them immediately. Fans should be operated during the spring to equalize the temperatures within the bin. The spring target temperature is 50 degrees Fahrenheit.

Proper monitoring requires a grain probe, a section of eaves trough or strip of canvas for handling the grain from the probe, screening pans for sifting insects from the grain samples, and a means of measuring temperatures in the grain. A record book of grain temperatures can help in detecting gradual increases in grain temperature. Slight increases are an early sign that heating and potential spoilage may be occurring. Thermometers or temperature monitoring systems can be used to measure the grain temperature.

## Storage Facilities

Soybeans can be stored on the farm in round bins or regular concrete-floor buildings. Drying is risky in flat storage because of possible poor air distribution. Beans held in storage, even though dry, need periodic aeration to minimize moisture migration and break up any hot spots that might develop. However, flat storage does have more versatility for other uses.

Beans must be moved very carefully as they are more susceptible to cracking and breakage than most grains. Augers should be operated at low speeds and full capacity to minimize damage. Belt conveyors are better than augers for moving beans. Grain augers are manufactured with bristles on the flighting to reduce the damage during handling. The bristle augers do not work in seed conditioning operations where avoidance of cross contamination of seeds is critical. Handling should be minimized and controlled by limiting drop heights and conveying. Grain spreaders should only be used with commercial beans and avoided when handling seed beans. Bin ladders can be used to reduce the damage due to drop distance during filling.

For information on planning a grain storage system, types of storage structures, and grain handling equipment, consult the *Grain Drying, Handling and Storage Handbook* (MWPS - 13), available for a nominal charge from Extension Biological and Agricultural Engineering offices at Kansas State University. County Extension offices have additional publications on drying, storing, and marketing soybeans. Other publications deal with insect control, temperature monitor systems, moisture meters, and steel bin selection.

# Profit Prospects

Total harvested acres of soybeans in Kansas remained fairly stable from 1990 to 1995 at about 1.975 million acres, or 9.25 percent of the state's harvested crop acres. In 1995, Kansas ranked 11th in the United States in the production of soybeans with 51.25 million bushels. Soybeans produced with irrigation represented 11.8 percent of the total soybean acres in 1995, with 68.3 percent of the irrigated acres in the central region of the state. In comparison, total nonirrigated soybean acreage in eastern Kansas was 1.63 million acres, or 79.5 percent of the state's total soybean acreage.

Each producer must answer two questions when selecting crops and the acreage of each crop to produce: (1) Will this choice be profitable? (2) Will this add more to the total net income of my farm operation than other choices? That is, is this the most profitable choice?

The fixed or overhead costs of land and machinery ownership for soybeans, corn, grain sorghum, and wheat will be basically equal for the production period under consideration. Therefore, the variable costs associated with each crop are the costs that need to be considered when selecting a given crop. Variable costs include labor, seed, herbicide, insecticide, fertilizer, fuel, oil, repairs, crop insurance, drying, custom work, crop consulting, and miscellaneous.

Variable costs will vary depending on the management practices used, tillage operations, labor efficiency, and type and fertility of the land. Each producer should develop the variable costs of production for soybeans and any other crop alternatives. Expected yield and selling price need to be determined for each crop alternative.

Budgeted variable costs by item are shown for nonirrigated soybean production in south central, north central, northeast, and southeast Kansas and for irrigated soybean production. A producer may have higher or lower

costs than those presented in these budgets. Nonirrigated soybean production in the western region of Kansas is not usually considered to be a profitable crop alternative, although it may be for a particular farm operation. In 1995, only 2,600 acres of nonirrigated soybeans were harvested in this region of the state.

The prices used in these tables are NOT price forecasts. They are used to indicate the method of computing expected returns above variable costs. These projections should be considered valid only under the costs, production levels, and prices specified. Individuals or groups using the information provided should substitute costs, production levels, and prices valid for the locality, management level to be adopted, marketing circumstances for the location, and time period involved.

The decision to plant soybeans or another crop alternative can be made by comparing the expected returns above variable costs for each crop. Returns above variable costs will depend on yields and prices. Each producer should use yields that are reasonable for the land or classes of land operated.

The decision to produce soybeans will depend primarily on the costs and expected returns for soybeans in comparison with other crop alternatives. However, the producer should take into account other variables such as previous crop rotation, livestock operation, and the machinery and labor requirements of each crop.

The type and amount of equipment, crop rotations, and farm size all affect the cost of producing crops. The tillage practices used and their timing also affect yields and production costs. Each producer should compute the expected returns above variable costs for the farm operation as a means of selecting the crops and acreage of each crop to produce. When computing expected returns above variable costs, consider a number of price alternatives.

## Estimated Variable Costs of Production

	Southeast	Northeast	South Central	North Central	Western	Irrigated*	My Farm
Soybeans	\$ 98	\$ 111	\$ 99	\$ 98	\$ --	\$ 162	_____
Corn	155	172	151	162	115	321	_____
Grain Sorghum	109	119	88	110	85	183	_____
Wheat	91	86	78	82	77	135	_____

\* For each crop, the values represent an average of the variable costs for flood and center pivot irrigation practices.



Expected Returns above Variable Costs for Soybeans

	Southeast	Northeast	South Central	North Central	*Irrigated	My Farm
Yield per acre	25	35	32	28	50	_____
Returns:						
Yield per acre x \$6.95	\$173.75	\$243.25	\$222.40	\$194.60	\$347.50	_____
Government Payments	\$ 8.61	\$ 10.64	\$ 14.98	\$ 13.18	\$ 13.96	_____
<b>TOTAL RETURNS</b>	<b>\$182.36</b>	<b>\$253.89</b>	<b>\$237.38</b>	<b>\$207.78</b>	<b>\$361.46</b>	_____
Variable Costs:						
Labor	18.45	18.45	18.00	18.00	18.00	_____
Seed	12.00	13.50	12.00	12.00	15.00	_____
Herbicide	27.17	27.17	27.17	27.17	27.17	_____
Insecticide	0.00	0.00	0.00	0.00	0.00	_____
Fertilizer-Lime	10.70	14.30	12.75	7.55	11.20	_____
Fuel and Oil-Crop	6.30	8.80	7.00	8.70	7.23	_____
Fuel and Oil-Pumping	0.00	0.00	0.00	0.00	39.77	_____
Machinery Repairs	13.50	18.71	12.50	15.26	18.64	_____
Irrigation Repairs	0.00	0.00	0.00	0.00	4.05	_____
Crop Insurance	0.00	0.00	0.00	0.00	0.00	_____
Drying	0.00	0.00	0.00	0.00	0.00	_____
Custom Hire	0.00	0.00	0.00	0.00	0.00	_____
Crop Consulting	0.00	0.00	0.00	0.00	6.25	_____
Miscellaneous	5.25	5.25	5.00	5.00	7.00	_____
Interest on 1/2 Variable Costs (10%)	4.67	5.31	4.72	4.68	7.72	_____
<b>TOTAL VARIABLE COSTS</b>	<b>\$ 98.04</b>	<b>\$111.49</b>	<b>\$ 99.14</b>	<b>\$98.36</b>	<b>\$162.03</b>	_____
<b>EXPECTED RETURNS ABOVE VARIABLE COSTS</b>	<b>\$ 84.32</b>	<b>\$142.40</b>	<b>\$138.24</b>	<b>\$109.42</b>	<b>\$199.43</b>	_____

\* The irrigated soybean budget represents an average of the variable costs for flood and center pivot irrigation practices. Fuel-oil and irrigation repair costs will vary slightly between flood and center pivot irrigation.

Southeast Kansas

	Yield	Price	Net Gov't Payments	Gross/Acre	Variable Costs	Return above Variable Costs	Fixed Costs*	Return above All Costs
Soybeans	25	\$6.95	\$8.61	\$182	\$ 98	\$ 84	\$ 75	\$ 9
Corn	85	2.95	8.61	259	155	104	75	29
Grain Sorghum	75	2.8	8.61	219	109	110	75	35
Wheat	35	4.15	8.61	154	91	63	75	-12

\* Based on \$625 per acre land at 6 percent; \$3.13 per acre taxes. Depreciation, interest, and insurance on \$255 per acre machinery investment equals \$34.

Northeast Kansas

	Yield	Price	Net Gov't Payments	Gross/Acre	Variable Costs	Return above Variable Costs	Fixed Costs*	Return above All Costs
Soybeans	35	\$6.95	\$10.64	\$254	\$111	\$143	\$84	\$59
Corn	100	2.95	10.64	306	172	134	84	50
Grain Sorghum	75	2.8	10.64	221	119	102	84	18
Wheat	35	4.15	10.64	156	86	70	84	-14

\* Based on \$775 per acre land at 6 percent; \$3.88 per acre taxes. Depreciation, interest, and insurance on \$255 per acre machinery investment equals \$34.

### South Central Kansas

	Yield	Price	Net Gov't Payments	Gross/ Acre	Variable Costs	Return above Variable Costs	Fixed Costs*	Return above All Costs
Soybeans	32	\$6.95	\$14.98	\$237	\$ 99	\$138	\$76	\$62
Corn	85	2.95	14.98	266	151	115	76	39
Grain Sorghum	60	2.8	14.98	183	88	95	76	19
Wheat	35	4.15	14.98	160	78	82	76	6

\* Based on \$675 per acre land at 6 percent; \$3.38 per acre taxes. Depreciation, interest, and insurance on \$240 per acre machinery investment equals \$32.

### North Central Kansas

	Yield	Price	Net Gov't Payments	Gross/ Acre	Variable Costs	Return above Variable Costs	Fixed Costs*	Return above All Costs
Soybeans	28	\$6.95	\$13.18	\$208	\$ 98	\$110	\$77	\$33
Corn	80	2.95	13.18	249	162	87	77	10
Grain Sorghum	70	2.8	13.18	209	110	99	77	22
Wheat	35	4.15	13.18	158	82	76	77	-1

\* Based on \$675 per acre land at 6 percent; \$3.38 per acre taxes. Depreciation, interest, and insurance on \$245 per acre machinery investment equals \$33.

### Western Kansas

	Yield	Price	Net Gov't Payments	Gross/ Acre	Variable Costs	Return above Variable Costs	Fixed Costs*	Return above All Costs
Corn	75	\$2.95	\$13.96	\$235	\$115	\$120	\$77	\$43
Grain Sorghum	60	2.8	13.96	182	85	97	77	20
Wheat	40	4.15	13.96	180	77	103	77	26

\* Based on 1.5 acres of land for each acre harvested. \$525 per acre land at 6 percent; \$3.94 per acre taxes. Depreciation, interest, and insurance on \$190 per acre machinery investment equals \$26.

### Irrigated Crops

	Yield	Price	Net Gov't Payments	Gross/ Acre	Variable Costs	Return above Variable Costs	Fixed Costs*	Return above All Costs
Soybeans	50	\$6.95	\$13.96	\$361	\$162	\$199	\$142	\$ 57
Corn	190	2.95	13.96	574	321	253	142	111
Grain Sorghum	110	2.8	13.96	322	183	139	142	-3
Wheat	65	4.15	13.96	284	135	149	142	7

\* Represents an average of flood and center pivot irrigation practices, and was based on \$870 per acre land at 6 percent; \$4.35 per acre taxes. Depreciation, interest, and insurance on \$715 machinery and irrigation equipment investment equals \$85. Center pivot irrigation would have depreciation, interest, and insurance expenses of \$116 on a machinery and irrigation equipment investment of \$930. Flood irrigation would have depreciation, interest, and insurance expenses of \$56 on a machinery and irrigation equipment investment of \$505.

### My Farm

	Yield	Price	Net Gov't Payments	Gross/ Acre	Variable Costs	Return above Variable Costs	Fixed Costs	Return above All Costs
Soybeans	_____	_____	_____	_____	_____	_____	_____	_____
Corn	_____	_____	_____	_____	_____	_____	_____	_____
Grain Sorghum	_____	_____	_____	_____	_____	_____	_____	_____
Wheat	_____	_____	_____	_____	_____	_____	_____	_____



Brand names appearing in this publication are for product identification purposes only. No endorsement is intended, nor is criticism implied of similar products not mentioned.

Publications from Kansas State University are available on the World Wide Web at: <http://www.oznet.ksu.edu>

Contents of this publication may be freely reproduced for educational purposes. All other rights reserved. In each case, credit authors, *Soybean Production Handbook*, Kansas State University, March 1997.

**Kansas State University Agricultural Experiment Station and Cooperative Extension Service**

C-449

March 1997

It is the policy of Kansas State University Agricultural Experiment Station and Cooperative Extension Service that all persons shall have equal opportunity and access to its educational programs, services, activities, and materials without regard to race, color, religion, national origin, sex, age or disability. Kansas State University is an equal opportunity organization. Issued in furtherance of Cooperative Extension Work, Acts of May 8 and June 30, 1914, as amended. Kansas State University, County Extension Councils, Extension Districts, and United States Department of Agriculture Cooperating, Marc A. Johnson, Director.

File code: Crops and Soils 1-5